



## High Pressure Equipment

### Accessories

High Pressure Equipment Company offers an extensive selection of accessory components to enable you to completely plumb a fluid system. These accessories allow you to move from tube to tube, tube to pipe, facilitate system pressure changes and monitor the temperatures and pressures within your system.

**Adapters** are available in both female to male and male to male configurations. Adapter models exist for all HiP connections and in the various pressure ranges to complement our valve and fitting lines.

**Couplings** enable you to make a wide variety of female to female connections. As with our adapters, couplings accommodate our complete line of valves and fittings. In addition, reducer couplings allow you to reduce line size within a given pressure range.

**Thermocouple adapters** are an excellent method to provide for temperature measurement in pressure systems up to 15,000 psi.

**Pressure gauges** are available in seven models to monitor system pressures ranging from atmosphere to 100,000 psi.



### Index

Page

#### Selection Guide:

- Female to Female Couplings . . .8.2-8.3
- Female to Male Adapters . . . .8.4-8.5
- Male to Male Adapters . . . . .8.6-8.7

#### Adapters:

- Female to Male . . . . .8.8-8.14

#### Adapters:

- Male to Male . . . . .8.15-8.18

#### Fittings:

- NPT . . . . .8.18.1-8.18.2
- Hose . . . . .8.18.3-8.18.4

#### Couplings:

- Female to Female . . . . .8.19-8.23

- Thermocouple Adapters . . . . .8.24

- Pressure Gauges . . . . .8.25



## High Pressure Equipment

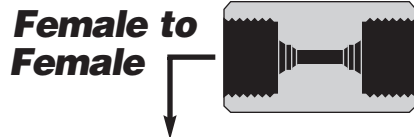

		AF1	AF2	AF4	AF6
		$\frac{1}{16}$ " Taper Seal	$\frac{1}{8}$ " Taper Seal	$\frac{1}{4}$ " Taper Seal	$\frac{3}{8}$ " Taper Seal
$\frac{1}{16}$ " TAPER SEAL	AF1	15-21AF1	15-21AF1AF2	10-21AF1AF4	10-21AF1AF6
$\frac{1}{8}$ " TAPER SEAL	AF2	15-21AF1AF2	15-21AF2	10-21AF2AF4	10-21AF2AF6
$\frac{1}{4}$ " TAPER SEAL	AF4	10-21AF1AF4	10-21AF2AF4	10-21AF4	10-21AF4AF6
$\frac{3}{8}$ " TAPER SEAL	AF6	10-21AF1AF6	10-21AF2AF6	10-21AF4AF6	10-21AF6
$\frac{1}{4}$ " MEDIUM PRESSURE	LF4	15-21AF1LF4	15-21AF2LF4	10-21AF4LF4	10-21AF6LF4
$\frac{3}{8}$ " MEDIUM PRESSURE	LF6	15-21AF1LF6	15-21AF2LF6	10-21AF4LF6	10-21AF6LF6
$\frac{9}{16}$ " MEDIUM PRESSURE	LF9	15-21AF1LF9	15-21AF2LF9	10-21AF4LF9	10-21AF6LF9
$\frac{3}{4}$ " MEDIUM PRESSURE	LF12	15-21AF1LF12	15-21AF2LF12	10-21AF4LF12	10-21AF6LF12
1" MEDIUM PRESSURE	LF16	15-21AF1LF16	15-21AF2LF16	10-21AF4LF16	10-21AF6LF16
$\frac{1}{8}$ " HIGH PRESSURE	HF2	15-21AF1HF2	15-21AF2HF2	10-21AF4HF2	10-21AF6HF2
$\frac{1}{4}$ " HIGH PRESSURE	HF4	15-21AF1HF4	15-21AF2HF4	10-21AF4HF4	10-21AF6HF4
$\frac{3}{8}$ " HIGH PRESSURE	HF6	15-21AF1HF6	15-21AF2HF6	10-21AF4HF6	10-21AF6HF6
$\frac{9}{16}$ " HIGH PRESSURE	HF9	15-21AF1HF9	15-21AF2HF9	10-21AF4HF9	10-21AF6HF9
1" HIGH PRESSURE	HF16	15-21AF1HF16	15-21AF2HF16	10-21AF4HF16	10-21AF6HF16
$\frac{1}{4}$ " ULTRA HIGH PRESSURE	XF4	15-21AF1XF4	15-21AF2XF4	10-21AF4XF4	10-21AF6XF4
$\frac{3}{8}$ " ULTRA HIGH PRESSURE	XF6	15-21AF1XF6	15-21AF2XF6	10-21AF4XF6	10-21AF6XF6
$\frac{1}{8}$ " NPT PIPE	NFA	15-21AF1NFA	15-21AF2NFA	10-21AF4NFA	10-21AF6NFA
$\frac{1}{4}$ " NPT PIPE	NFB	15-21AF1NFB	15-21AF2NFB	10-21AF4NFB	10-21AF6NFB
$\frac{3}{8}$ " NPT PIPE	NFC	15-21AF1NFC	15-21AF2NFC	10-21AF4NFC	10-21AF6NFC
$\frac{1}{2}$ " NPT PIPE	NFD	15-21AF1NFD	15-21AF2NFD	10-21AF4NFD	10-21AF6NFD
$\frac{3}{4}$ " NPT PIPE	NFF	10-21AF1NFF	10-21AF2NFF	10-21AF4NFF	10-21AF6NFF
1" NPT PIPE	NFH	10-21AF1NFH	10-21AF2NFH	10-21AF4NFH	10-21AF6NFH

### Female to Female (continued)

		HF6	HF9	HF16	XF4
		$\frac{3}{8}$ " High Pressure	$\frac{9}{16}$ " High Pressure	1" High Pressure	$\frac{1}{4}$ " Ultra High Pressure
$\frac{1}{16}$ " TAPER SEAL	AF1	15-21AF1HF6	15-21AF1HF9	15-21AF1HF16	15-21AF1XF4
$\frac{1}{8}$ " TAPER SEAL	AF2	15-21AF2HF6	15-21AF2HF9	15-21AF2HF16	15-21AF2XF4
$\frac{1}{4}$ " TAPER SEAL	AF4	10-21AF4HF6	10-21AF4HF9	10-21AF4HF16	10-21AF4XF4
$\frac{3}{8}$ " TAPER SEAL	AF6	10-21AF6HF6	10-21AF6HF9	10-21AF6HF16	10-21AF6XF4
$\frac{1}{4}$ " MEDIUM PRESSURE	LF4	20-21LF4HF6	20-21LF4HF9	20-21LF4HF16	20-21LF4XF4
$\frac{3}{8}$ " MEDIUM PRESSURE	LF6	20-21LF6HF6	20-21LF6HF9	20-21LF6HF16	20-21LF6XF4
$\frac{9}{16}$ " MEDIUM PRESSURE	LF9	20-21LF9HF6	20-21LF9HF9	20-21LF9HF16	20-21LF9XF4
$\frac{3}{4}$ " MEDIUM PRESSURE	LF12	20-21LF12HF6	20-21LF12HF9	20-21LF12HF16	20-21LF12XF4
1" MEDIUM PRESSURE	LF16	20-21LF16HF6	20-21LF16HF9	20-21LF16HF16	20-21LF16XF4
$\frac{1}{8}$ " HIGH PRESSURE	HF2	60-21HF2HF6	60-21HF2HF9	30-21HF2HF16	60-21HF2XF4
$\frac{1}{4}$ " HIGH PRESSURE	HF4	60-21HF4HF6	60-21HF4HF9	30-21HF4HF16	60-21HF4XF4
$\frac{3}{8}$ " HIGH PRESSURE	HF6	60-21HF6	60-21HF6HF9	30-21HF6HF16	60-21HF6XF4
$\frac{9}{16}$ " HIGH PRESSURE	HF9	60-21HF6HF9	60-21HF9	30-21HF9HF16	60-21HF9XF4
1" HIGH PRESSURE	HF16	30-21HF6HF16	30-21HF9HF16	30-21HF16	30-21HF16XF4
$\frac{1}{4}$ " ULTRA HIGH PRESSURE	XF4	60-21HF6XF4	60-21HF9XF4	30-21HF16XF4	100-21XF4
$\frac{3}{8}$ " ULTRA HIGH PRESSURE	XF6	60-21HF6XF6	60-21HF9XF6	30-21HF16XF6	100-21XF4XF6
$\frac{1}{8}$ " NPT PIPE	NFA	30-21HF6NFA	30-21HF9NFA	30-21HF16NFA	30-21XF4NFA
$\frac{1}{4}$ " NPT PIPE	NFB	30-21HF6NFB	30-21HF9NFB	30-21HF16NFB	30-21XF4NFB
$\frac{3}{8}$ " NPT PIPE	NFC	30-21HF6NFC	30-21HF9NFC	30-21HF16NFC	30-21XF4NFC
$\frac{1}{2}$ " NPT PIPE	NFD	30-21HF6NFD	30-21HF9NFD	30-21HF16NFD	30-21XF4NFD
$\frac{3}{4}$ " NPT PIPE	NFF	10-21HF6NFF	10-21HF9NFF	10-21HF16NFF	10-21XF4NFF
1" NPT PIPE	NFH	10-21HF6NFH	10-21HF9NFH	10-21HF16NFH	10-21XF4NFH

# Coupling Selection Guide

	LF4	LF6	LF9	LF12	LF16	HF2	HF4
	1/4" Medium Pressure	3/8" Medium Pressure	9/16" Medium Pressure	3/4" Medium Pressure	1" Medium Pressure	1/8" High Pressure	1/4" High Pressure
	15-21AF1LF4	15-21AF1LF6	15-21AF1LF9	15-21AF1LF12	15-21AF1LF16	15-21AF1HF2	15-21AF1HF4
	15-21AF2LF4	15-21AF2LF6	15-21AF2LF9	15-21AF2LF12	15-21AF2LF16	15-21AF2HF2	15-21AF2HF4
	10-21AF4LF4	10-21AF4LF6	10-21AF4LF9	10-21AF4LF12	10-21AF4LF16	10-21AF4HF2	10-21AF4HF4
	10-21AF6LF4	10-21AF6LF6	10-21AF6LF9	10-21AF6LF12	10-21AF6LF16	10-21AF6HF2	10-21AF6HF4
	20-21LF4	20-21LF4LF6	10-21LF4LF9	20-21LF4LF12	20-21LF4LF16	20-21LF4HF2	20-21LF4HF4
	20-21LF4LF6	20-21LF6	20-21LF6LF9	20-21LF6LF12	20-21LF6LF16	20-21LF6HF2	20-21LF6HF4
	20-21LF4LF9	20-21LF6LF9	20-21LF9	20-21LF9LF12	20-21LF9LF16	20-21LF9HF2	20-21LF9HF4
	20-21LF4LF12	20-21LF6LF12	20-21LF9LF12	20-21LF12	20-21LF12LF16	20-21LF12HF2	20-21LF12HF4
	20-21LF4LF16	20-21LF6LF16	20-21LF9LF16	20-21LF12LF16	20-21LF16	20-21LF16HF2	20-21LF16HF4
	20-21LF4HF2	20-21LF6HF2	20-21LF9HF2	20-21LF12HF2	20-21LF16HF2	60-21HF2	60-21HF2HF4
	20-21LF4HF4	20-21LF6HF4	20-21LF9HF4	20-21LF12HF4	20-21LF16HF4	60-21HF2HF4	60-21HF4
	20-21LF4HF6	20-21LF6HF6	20-21LF9HF6	20-21LF12HF6	20-21LF16HF6	60-21HF2HF6	60-21HF4HF6
	20-21LF4HF9	20-21LF6HF9	20-21LF9HF9	20-21LF12HF9	20-21LF16HF9	60-21HF2HF9	60-21HF4HF9
	20-21LF4HF16	20-21LF6HF16	20-21LF9HF16	20-21LF12HF16	20-21LF16HF16	30-21HF2HF16	30-21HF4HF16
	20-21LF4XF4	20-21LF6XF4	20-21LF9XF4	20-21LF12XF4	20-21LF16XF4	60-21HF2XF4	60-21HF4XF4
	20-21LF4XF6	20-21LF6XF6	20-21LF9XF6	20-21LF12XF6	20-21LF16XF6	60-21HF2XF6	60-21HF4XF6
	20-21LF4NFA	20-21LF6NFA	20-21LF9NFA	20-21LF12NFA	20-21LF16NFA	30-21HF2NFA	30-21HF4NFA
	20-21LF4NFB	20-21LF6NFB	20-21LF9NFB	20-21LF12NFB	20-21LF16NFB	30-21HF2NFB	30-21HF4NFB
	20-21LF4NFC	20-21LF6NFC	20-21LF9NFC	20-21LF12NFC	20-21LF16NFC	30-21HF2NFC	30-21HF4NFC
	20-21LF4NFD	20-21LF6NFD	20-21LF9NFD	20-21LF12NFD	20-21LF16NFD	30-21HF2NFD	30-21HF4NFD
	10-21LF4NFF	10-21LF6NFF	10-21LF9NFF	10-21LF12NFF	10-21LF16NFF	10-21HF2NFF	10-21HF4NFF
	10-21LF4NFH	10-21LF6NFH	10-21LF9NFH	10-21LF12NFH	10-21LF16NFH	10-21HF2NFH	10-21HF4NFH

	XF6	NFA	NFB	NFC	NFD	NFF	NFH
	3/8" Ultra High Pressure	1/8" NPT Pipe	1/4" NPT Pipe	3/8" NPT Pipe	1/2" NPT Pipe	3/4" NPT Pipe	1" NPT Pipe
	15-21AF1XF6	15-21AF1NFA	15-21AF1NFB	15-21AF1NFC	15-21AF1NFD	10-21AF1NFF	10-21AF1NFH
	15-21AF2XF6	15-21AF2NFA	15-21AF2NFB	15-21AF2NFC	15-21AF2NFD	10-21AF2NFF	10-21AF2NFH
	10-21AF4XF6	10-21AF4NFA	10-21AF4NFB	10-21AF4NFC	10-21AF4NFD	10-21AF4NFF	10-21AF4NFH
	10-21AF6XF6	10-21AF6NFA	10-21AF6NFB	10-21AF6NFC	10-21AF6NFD	10-21AF6NFF	10-21AF6NFH
	20-21LF4XF6	20-21LF4NFA	20-21LF4NFB	20-21LF4NFC	20-21LF4NFD	10-21LF4NFF	10-21LF4NFH
	20-21LF6XF6	20-21LF6NFA	20-21LF6NFB	20-21LF6NFC	20-21LF6NFD	10-21LF6NFF	10-21LF6NFH
	20-21LF9XF6	20-21LF9NFA	20-21LF9NFB	20-21LF9NFC	20-21LF9NFD	10-21LF9NFF	10-21LF9NFH
	20-21LF12XF6	20-21LF12NFA	20-21LF12NFB	20-21LF12NFC	20-21LF12NFD	10-21LF12NFF	10-21LF12NFH
	20-21LF16XF6	20-21LF16NFA	20-21LF16NFB	20-21LF16NFC	20-21LF16NFD	10-21LF16NFF	10-21LF16NFH
	60-21HF2XF6	30-21HF2NFA	30-21HF2NFB	30-21HF2NFC	30-21HF2NFD	10-21HF2NFF	10-21HF2NFH
	60-21HF4XF6	30-21HF4NFA	30-21HF4NFB	30-21HF4NFC	30-21HF4NFD	10-21HF4NFF	10-21HF4NFH
	60-21HF6XF6	30-21HF6NFA	30-21HF6NFB	30-21HF6NFC	30-21HF6NFD	10-21HF6NFF	10-21HF6NFH
	60-21HF9XF6	30-21HF9NFA	30-21HF9NFB	30-21HF9NFC	30-21HF9NFD	10-21HF9NFF	10-21HF9NFH
	30-21HF16XF6	30-21HF16NFA	30-21HF16NFB	30-21HF16NFC	30-21HF16NFD	10-21HF16NFF	10-21HF16NFH
	100-21XF4XF6	30-21XF4NFA	30-21XF4NFB	30-21XF4NFC	30-21XF4NFD	10-21XF4NFF	10-21XF4NFH
	150-21XF6	30-21XF6NFA	30-21XF6NFB	30-21XF6NFC	30-21XF6NFD	10-21XF6NFF	10-21XF6NFH
	30-21XF6NFA	15-21NFA	15-21NFANFB	15-21NFANFC	15-21NFANFD	10-21NFANFF	10-21NFANFH
	30-21XF6NFB	15-21NFANFB	15-21NFB	15-21NFBNFC	15-21NFBNFD	10-21NFBNFF	10-21NFBNFH
	30-21XF6NFC	15-21NFANFC	15-21NFBNFC	15-21NFC	15-21NFCNFD	10-21NFCNFF	10-21NFCNFH
	30-21XF6NFD	15-21NFANFD	15-21NFBNFD	15-21NFCNFD	15-21NFD	10-21NFDNFF	10-21NFDNFH
	10-21XF6NFF	10-21NFANFF	10-21NFBNFF	10-21NFCNFF	10-21NFDNFF	10-21NFF	10-21NFFNFH
	10-21XF6NFH	10-21NFANFH	10-21NFBNFH	10-21NFCNFH	10-21NFDNFH	10-21NFFNFH	10-21NFH



## High Pressure Equipment

**Female to Male**

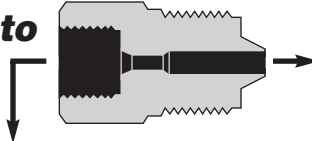

		AM1	AM2	AM4	AM6
		$\frac{1}{16}$ " Taper Seal	$\frac{1}{8}$ " Taper Seal	$\frac{1}{4}$ " Taper Seal	$\frac{3}{8}$ " Taper Seal
$\frac{1}{16}$ " TAPER SEAL	AF1	15-21AF1AM1	15-21AF1AM2	10-21AF1AM4	10-21AF1AM6
$\frac{1}{8}$ " TAPER SEAL	AF2	15-21AF2AM1	15-21AF2AM2	10-21AF2AM4	10-21AF2AM6
$\frac{1}{4}$ " TAPER SEAL	AF4	10-21AF4AM1	10-21AF4AM2	10-21AF4AM4	10-21AF4AM6
$\frac{3}{8}$ " TAPER SEAL	AF6	10-21AF6AM1	10-21AF6AM2	10-21AF6AM4	10-21AF6AM6
$\frac{1}{4}$ " MEDIUM PRESSURE	LF4	15-21LF4AM1	15-21LF4AM2	10-21LF4AM4	10-21LF4AM6
$\frac{3}{8}$ " MEDIUM PRESSURE	LF6	15-21LF6AM1	15-21LF6AM2	10-21LF6AM4	10-21LF6AM6
$\frac{9}{16}$ " MEDIUM PRESSURE	LF9	15-21LF9AM1	15-21LF9AM2	10-21LF9AM4	10-21LF9AM6
$\frac{3}{4}$ " MEDIUM PRESSURE	LF12	15-21LF12AM1	15-21LF12AM2	10-21LF12AM4	10-21LF12AM6
1" MEDIUM PRESSURE	LF16	15-21LF16AM1	15-21LF16AM2	10-21LF16AM4	10-21LF16AM6
$\frac{1}{8}$ " HIGH PRESSURE	HF2	15-21HF2AM1	15-21HF2AM2	10-21HF2AM4	10-21HF2AM6
$\frac{1}{4}$ " HIGH PRESSURE	HF4	15-21HF4AM1	15-21HF4AM2	10-21HF4AM4	10-21HF4AM6
$\frac{3}{8}$ " HIGH PRESSURE	HF6	15-21HF6AM1	15-21HF6AM2	10-21HF6AM4	10-21HF6AM6
$\frac{9}{16}$ " HIGH PRESSURE	HF9	15-21HF9AM1	15-21HF9AM2	10-21HF9AM4	10-21HF9AM6
1" HIGH PRESSURE	HF16	15-21HF16AM1	15-21HF16AM2	10-21HF16AM4	10-21HF16AM6
$\frac{1}{4}$ " ULTRA HIGH PRESSURE	XF4	15-21XF4AM1	15-21XF4AM2	10-21XF4AM4	10-21XF4AM6
$\frac{3}{8}$ " ULTRA HIGH PRESSURE	XF6	15-21XF6AM1	15-21XF6AM2	10-21XF6AM4	10-21XF6AM6
$\frac{1}{8}$ " NPT PIPE	NFA	15-21NFAAM1	15-21NFAAM2	10-21NFAAM4	10-21NFAAM6
$\frac{1}{4}$ " NPT PIPE	NFB	15-21NFBAM1	15-21NFBAM2	10-21NFBAM4	10-21NFBAM6
$\frac{3}{8}$ " NPT PIPE	NFC	15-21NFCAM1	15-21NFCAM2	10-21NFCAM4	10-21NFCAM6
$\frac{1}{2}$ " NPT PIPE	NFD	15-21NFDAM1	15-21NFDAM2	10-21NFDAM4	10-21NFDAM6
$\frac{3}{4}$ " NPT PIPE	NFF	10-21NFFAM1	10-21NFFAM2	10-21NFFAM4	10-21NFFAM6
1" NPT PIPE	NFH	10-21NFHAM1	10-21NFHAM2	10-21NFHAM4	10-21NFHAM6

**Female to Male**  
**(continued)**

		HM6	HM9	HM16	XM4
		$\frac{3}{8}$ " High Pressure	$\frac{9}{16}$ " High Pressure	1" High Pressure	$\frac{1}{4}$ " Ultra High Pressure
$\frac{1}{16}$ " TAPER SEAL	AF1	15-21AF1HM6	15-21AF1HM9	15-21AF1HM16	15-21AF1XM4
$\frac{1}{8}$ " TAPER SEAL	AF2	15-21AF2HM6	15-21AF2HM9	15-21AF2HM16	15-21AF2XM4
$\frac{1}{4}$ " TAPER SEAL	AF4	10-21AF4HM6	10-21AF4HM9	10-21AF4HM16	10-21AF4XM4
$\frac{3}{8}$ " TAPER SEAL	AF6	10-21AF6HM6	10-21AF6HM9	10-21AF6HM16	10-21AF6XM4
$\frac{1}{4}$ " MEDIUM PRESSURE	LF4	20-21LF4HM6	20-21LF4HM9	20-21LF4HM16	20-21LF4XM4
$\frac{3}{8}$ " MEDIUM PRESSURE	LF6	20-21LF6HM6	20-21LF6HM9	20-21LF6HM16	20-21LF6XM4
$\frac{9}{16}$ " MEDIUM PRESSURE	LF9	20-21LF9HM6	20-21LF9HM9	20-21LF9HM16	20-21LF9XM4
$\frac{3}{4}$ " MEDIUM PRESSURE	LF12	20-21LF12HM6	20-21LF12HM9	20-21LF12HM16	20-21LF12XM4
1" MEDIUM PRESSURE	LF16	20-21LF16HM6	20-21LF16HM9	20-21LF16HM16	20-21LF16XM4
$\frac{1}{8}$ " HIGH PRESSURE	HF2	60-21HF2HM6	60-21HF2HM9	30-21HF2HM16	60-21HF2XM4
$\frac{1}{4}$ " HIGH PRESSURE	HF4	60-21HF4HM6	60-21HF4HM9	30-21HF4HM16	60-21HF4XM4
$\frac{3}{8}$ " HIGH PRESSURE	HF6	60-21HF6HM6	60-21HF6HM9	30-21HF6HM16	60-21HF6XM4
$\frac{9}{16}$ " HIGH PRESSURE	HF9	60-21HF9HM6	60-21HF9HM9	30-21HF9HM16	60-21HF9XM4
1" HIGH PRESSURE	HF16	30-21HF16HM6	30-21HF16HM9	30-21HF16HM16	30-21HF16XM4
$\frac{1}{4}$ " ULTRA HIGH PRESSURE	XF4	60-21XF4HM6	60-21XF4HM9	30-21XF4HM16	100-21XF4XM4
$\frac{3}{8}$ " ULTRA HIGH PRESSURE	XF6	60-21XF6HM6	60-21XF6HM9	30-21XF6HM16	100-21XF6XM4
$\frac{1}{8}$ " NPT PIPE	NFA	30-21NFAHM6	30-21NFAHM9	30-21NFAHM16	30-21NFAXM4
$\frac{1}{4}$ " NPT PIPE	NFB	30-21NFBHM6	30-21NFBHM9	30-21NFBHM16	30-21NFBXM4
$\frac{3}{8}$ " NPT PIPE	NFC	30-21NFCM6	30-21NFCM9	30-21NFCM16	30-21NFCXM4
$\frac{1}{2}$ " NPT PIPE	NFD	30-21NFDHM6	30-21NFDHM9	30-21NFDHM16	30-21NFDXM4
$\frac{3}{4}$ " NPT PIPE	NFF	10-21NFFHM6	10-21NFFHM9	10-21NFFHM16	10-21NFFXM4
1" NPT PIPE	NFH	10-21NFHHM6	10-21NFHHM9	10-21NFHHM16	10-21NFHXM4

# Adapter Selection Guide

	LM4	LM6	LM9	LM12	LM16	HM2	HM4
	1/4" Medium Pressure	3/8" Medium Pressure	9/16" Medium Pressure	3/4" Medium Pressure	1" Medium Pressure	1/8" High Pressure	1/4" High Pressure
	15-21AF1LM4	15-21AF1LM6	15-21AF1LM9	15-21AF1LM12	15-21AF1LM16	15-21AF1HM2	15-21AF1HM4
	15-21AF2LM4	15-21AF2LM6	15-21AF2LM9	15-21AF2LM12	15-21AF2LM16	15-21AF2HM2	15-21AF2HM4
	10-21AF4LM4	10-21AF4LM6	10-21AF4LM9	10-21AF4LM12	10-21AF4LM16	10-21AF4HM2	10-21AF4HM4
	10-21AF6LM4	10-21AF6LM6	10-21AF6LM9	10-21AF6LM12	10-21AF6LM16	10-21AF6HM2	10-21AF6HM4
	20-21LF4LM4	20-21LF4LM6	20-21LF4LM9	20-21LF4LM12	20-21LF4LM16	20-21LF4HM2	20-21LF4HM4
	20-21LF6LM4	20-21LF6LM6	20-21LF6LM9	20-21LF6LM12	20-21LF6LM16	20-21LF6HM2	20-21LF6HM4
	20-21LF9LM4	20-21LF9LM6	20-21LF9LM9	20-21LF9LM12	20-21LF9LM16	20-21LF9HM2	20-21LF9HM4
	20-21LF12LM4	20-21LF12LM6	20-21LF12LM9	20-21LF12LM12	20-21LF12LM16	20-21LF12HM2	20-21LF12HM4
	20-21LF16LM4	20-21LF16LM6	20-21LF16LM9	20-21LF16LM12	20-21LF16LM16	20-21LF16HM2	20-21LF16HM4
	20-21HF2LM4	20-21HF2LM6	20-21HF2LM9	20-21HF2LM12	20-21HF2LM16	60-21HF2HM2	60-21HF2HM4
	20-21HF4LM4	20-21HF4LM6	20-21HF4LM9	20-21HF4LM12	20-21HF4LM16	60-21HF4HM2	60-21HF4HM4
	20-21HF6LM4	20-21HF6LM6	20-21HF6LM9	20-21HF6LM12	20-21HF6LM16	60-21HF6HM2	60-21HF6HM4
	20-21HF9LM4	20-21HF9LM6	20-21HF9LM9	20-21HF9LM12	20-21HF9LM16	60-21HF9HM2	60-21HF9HM4
	20 21HF16LM4	20-21HF16LM6	20-21HF16LM9	20-21HF16LM12	20-21HF16LM16	30-21HF16HM2	30-21HF16HM4
	20-21XF4LM4	20-21XF4LM6	20-21XF4LM9	20-21XF4LM12	20-21XF4LM16	60-21XF4HM2	60-21XF4HM4
	20-21XF6LM4	20-21XF6LM6	20-21XF6LM9	20-21XF6LM12	20-21XF6LM16	60-21XF6HM2	60-21XF6HM4
	20-21NFALM4	20-21NFALM6	20-21NFALM9	20-21NFALM12	20-21NFALM16	30-21NFAHM2	30-21NFAHM4
	20-21NFBLM4	20-21NFBLM6	20-21NFBLM9	20-21NFBLM12	20-21NFBLM16	30-21NFBHM2	30-21NFBHM4
	20-21NFCLM4	20-21NFCLM6	20-21NFCLM9	20-21NFCLM12	20-21NFCLM16	30-21NFCM2	30-21NFCM4
	20-21NFDLM4	20-21NFDLM6	20-21NFDLM9	20-21NFDLM12	20-21NFDLM16	30-21NFDHM2	30-21NFDHM4
	10-21NFFLM4	10-21NFFLM6	10-21NFFLM9	10-21NFFLM12	10-21NFFLM16	10-21NFFHM2	10-21NFFHM4
	10-21NFHLM4	10-21NFHLM6	10-21NFHLM9	10-21NFHLM12	10-21NFHLM16	10-21NFHHM2	10-21NFHHM4

	XM6	NMA	NMB	NMC	NMD	NMF	NMH
	3/8" Ultra High Pressure	1/8" NPT Pipe	1/4" NPT Pipe	3/8" NPT Pipe	1/2" NPT Pipe	3/4" NPT Pipe	1" NPT Pipe
	15-21AF1XM6	15-21AF1NMA	15-21AF1NMB	15-21AF1NMC	15-21AF1NMD	10-21AF1NMF	10-21AF1NMH
	15-21AF2XM6	15-21AF2NMA	15-21AF2NMB	15-21AF2NMC	15-21AF2NMD	10-21AF2NMF	10-21AF2NMH
	10-21AF4XM6	10-21AF4NMA	10-21AF4NMB	10-21AF4NMC	10-21AF4NMD	10-21AF4NMF	10-21AF4NMH
	10-21AF6XM6	10-21AF6NMA	10-21AF6NMB	10-21AF6NMC	10-21AF6NMD	10-21AF6NMF	10-21AF6NMH
	20-21LF4XM6	20-21LF4NMA	20-21LF4NMB	20-21LF4NMC	20-21LF4NMD	10-21LF4NMF	10-21LF4NMH
	20-21LF6XM6	20-21LF6NMA	20-21LF6NMB	20-21LF6NMC	20-21LF6NMD	10-21LF6NMF	10-21LF6NMH
	20-21LF9XM6	20-21LF9NMA	20-21LF9NMB	20-21LF9NMC	20-21LF9NMD	10-21LF9NMF	10-21LF9NMH
	20-21LF12XM6	20-21LF12NMA	20-21LF12NMB	20-21LF12NMC	20-21LF12NMD	10-21LF12NMF	10-21LF12NMH
	20-21LF16XM6	20-21LF16NMA	20-21LF16NMB	20-21LF16NMC	20-21LF16NMD	10-21LF16NMF	10-21LF16NMH
	60-21HF2XM6	30-21HF2NMA	30-21HF2NMB	30-21HF2NMC	30-21HF2NMD	10-21HF2NMF	10-21HF2NMH
	60-21HF4XM6	30-21HF4NMA	30-21HF4NMB	30-21HF4NMC	30-21HF4NMD	10-21HF4NMF	10-21HF4NMH
	60-21HF6XM6	30-21HF6NMA	30-21HF6NMB	30-21HF6NMC	30-21HF6NMD	10-21HF6NMF	10-21HF6NMH
	60-21HF9XM6	30-21HF9NMA	30-21HF9NMB	30-21HF9NMC	30-21HF9NMD	10-21HF9NMF	10-21HF9NMH
	30-21HF16XM6	30-21HF16NMA	30-21HF16NMB	30-21HF16NMC	30-21HF16NMD	10-21HF16NMF	10-21HF16NMH
	100-21XF4XM6	30-21XF4NMA	30-21XF4NMB	30-21XF4NMC	30-21XF4NMD	10-21XF4NMF	10-21XF4NMH
	150-21XF6XM6	30-21XF6NMA	30-21XF6NMB	30-21XF6NMC	30-21XF6NMD	10-21XF6NMF	10-21XF6NMH
	30-21NFAXM6	15-21NFANMA	15-21NFANMB	15-21NFANMC	15-21NFANMD	10-21NFANMF	10-21NFANMH
	30-21NFBXM6	15-21NFBNMA	15-21NFBNMB	15-21NFBNMC	15-21NFBNMD	10-21NFBNMF	10-21NFBNMH
	30-21NFCXM6	15-21NFCNMA	15-21NFCNMB	15-21NFCNMC	15-21NFCNMD	10-21NFCNMF	10-21NFCNMH
	30-21NFDXM6	15-21NFDNMA	15-21NFDNMB	15-21NFDNMC	15-21NFDNMD	10-21NFDNMF	10-21NFDNMH
	10-21NFFXM6	10-21NFFNMA	10-21NFFNMB	10-21NFFNMC	10-21NFFNMD	10-21NFFNMF	10-21NFFNMH
	10-21NFHXM6	10-21NFHNMA	10-21NFHNMB	10-21NFHNMC	10-21NFHNMD	10-21NFHNMF	10-21NFHNMH





## High Pressure Equipment

**Male to Male**

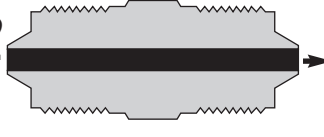

		AM1	AM2	AM4	AM6
		1/16" Taper Seal	1/8" Taper Seal	1/4" Taper Seal	3/8" Taper Seal
1/16" TAPER SEAL	AM1	15-21AM1AM1	15-21AM1AM2	10-21AM1AM4	10-21AM1AM6
1/8" TAPER SEAL	AM2	15-21AM1AM2	15-21AM2AM2	10-21AM2AM4	10-21AM2AM6
1/4" TAPER SEAL	AM4	10-21AM1AM4	10-21AM2AM4	10-21AM4AM4	10-21AM4AM6
3/8" TAPER SEAL	AM6	10-21AM1AM6	10-21AM2AM6	10-21AM4AM6	10-21AM6AM6
1/4" MEDIUM PRESSURE	LM4	15-21AM1LM4	15-21AM2LM4	10-21AM4LM4	10-21AM6LM4
3/8" MEDIUM PRESSURE	LM6	15-21AM1LM6	15-21AM2LM6	10-21AM4LM6	10-21AM6LM6
9/16" MEDIUM PRESSURE	LM9	15-21AM1LM9	5-21AM2LM9	10-21AM4LM9	10-21AM6LM9
3/4" MEDIUM PRESSURE	LM12	15-21AM1LM12	15-21AM2LM12	10-21AM4LM12	10-21AM6LM12
1" MEDIUM PRESSURE	LM16	15-21AM1LM16	15-21AM2LM16	10-21AM4LM16	10-21AM6LM16
1/8" HIGH PRESSURE	HM2	15-21AM1HM2	15-21AM2HM2	10-21AM4HM2	10-21AM6HM2
1/4" HIGH PRESSURE	HM4	15-21AM1HM4	15-21AM2HM4	10-21AM4HM4	10-21AM6HM4
3/8" HIGH PRESSURE	HM6	15-21AM1HM6	15-21AM2HM6	10-21AM4HM6	10-21AM6HM6
9/16" HIGH PRESSURE	HM9	15-21AM1HM9	15-21AM2HM9	10-21AM4HM9	10-21AM6HM9
1" HIGH PRESSURE	HM16	15-21AM1HM16	15-21AM2HM16	10-21AM4HM16	10-21AM6HM16
1/4" ULTRA HIGH PRESSURE	XM4	15-21AM1XM4	15-21AM2XM4	10-21AM4XM4	10-21AM6XM4
3/8" ULTRA HIGH PRESSURE	XM6	15-21AM1XM6	15-21AM2XM6	10-21AM4XM6	10-21AM6XM6
1/8" NPT PIPE	NMA	15-21AM1NMA	15-21AM2NMA	10-21AM4NMA	10-21AM6NMA
1/4" NPT PIPE	NMB	15-21AM1NMB	15-21AM2NMB	10-21AM4NMB	10-21AM6NMB
3/8" NPT PIPE	NMC	15-21AM1NMC	15-21AM2NMC	10-21AM4NMC	10-21AM6NMC
1/2" NPT PIPE	NMD	15-21AM1NMD	15-21AM2NMD	10-21AM4NMD	10-21AM6NMD
3/4" NPT PIPE	NMF	10-21AM1NMF	10-21AM2NMF	10-21AM4NMF	10-21AM6NMF
1" NPT PIPE	NMH	10-21AM1NMH	10-21AM2NMH	10-21AM4NMH	10-21AM6NMH

**Male to Male**  
(continued)

		HM6	HM9	HM16	XM4
		3/8" High Pressure	9/16" High Pressure	1" High Pressure	1/4" Ultra High Pressure
1/16" TAPER SEAL	AM1	15-21AM1HM6	15-21AM1HM9	15-21AM1HM16	15-21AM1XM4
1/8" TAPER SEAL	AM2	15-21AM2HM6	15-21AM2HM9	15-21AM2HM16	15-21AM2XM4
1/4" TAPER SEAL	AM4	10-21AM4HM6	10-21AM4HM9	10-21AM4HM16	10-21AM4XM4
3/8" TAPER SEAL	AM6	10-21AM6HM6	10-21AM6HM9	10-21AM6HM16	10-21AM6XM4
1/4" MEDIUM PRESSURE	LM4	20-21LM4HM6	20-21LM4HM9	20-21LM4HM16	20-21LM4XM4
3/8" MEDIUM PRESSURE	LM6	20-21LM6HM6	20-21LM6HM9	20-21LM6HM16	20-21LM6XM4
9/16" MEDIUM PRESSURE	LM9	20-21LM9HM6	20-21LM9HM9	20-21LM9HM16	20-21LM9XM4
3/4" MEDIUM PRESSURE	LM12	20-21LM12HM6	20-21LM12HM9	20-21LM12HM16	20-21LM12XM4
1" MEDIUM PRESSURE	LM16	20-21LM16HM6	20-21LM16HM9	20-21LM16HM16	20-21LM16XM4
1/8" HIGH PRESSURE	HM2	60-21HM2HM6	60-21HM2HM9	60-21HM2HM16	60-21HM2XM4
1/4" HIGH PRESSURE	HM4	60-21HM4HM6	60-21HM4HM9	60-21HM4HM16	60-21HM4XM4
3/8" HIGH PRESSURE	HM6	60-21HM6HM6	60-21HM6HM9	60-21HM6HM16	60-21HM6XM4
9/16" HIGH PRESSURE	HM9	60-21HM9HM6	60-21HM9HM9	30-21HM9HM16	60-21HM9XM4
1" HIGH PRESSURE	HM16	30-21HM6HM16	30-21HM9HM16	30-21HM16HM16	30-21HM16XM4
1/4" ULTRA HIGH PRESSURE	XM4	60-21HM6XM4	60-21HM9XM4	60-21HM16XM4	100-21XM4XM4
3/8" ULTRA HIGH PRESSURE	XM6	60-21HM6XM6	60-21HM9XM6	60-21HM16XM6	100-21XM4XM6
1/8" NPT PIPE	NMA	30-21HM6NMA	30-21HM9NMA	30-21HM16NMA	30-21XM4NMA
1/4" NPT PIPE	NMB	30-21HM6NMB	30-21HM9NMB	30-21HM16NMB	30-21XM4NMB
3/8" NPT PIPE	NMC	30-21HM6NMC	30-21HM9NMC	30-21HM16NMC	30-21XM4NMC
1/2" NPT PIPE	NMD	30-21HM6NMD	30-21HM9NMD	30-21HM16NMD	30-21XM4NMD
3/4" NPT PIPE	NMF	10-21HM6NMF	10-21HM9NMF	10-21HM16NMF	10-21XM4NMF
1" NPT PIPE	NMH	10-21HM6NMH	10-21HM9NMH	10-21HM16NMH	10-21XM4NMH

# Adapter Selection Guide

	LM4	LM6	LM9	LM12	LM16	HM2	HM4
	1/4" Medium Pressure	3/8" Medium Pressure	9/16" Medium Pressure	3/4" Medium Pressure	1" Medium Pressure	1/8" High Pressure	1/4" High Pressure
	15-21AM1LM4	15-21AM1LM6	15-21AM1LM9	15-21AM1LM12	15-21AM1LM16	15-21AM1HM2	15-21AM1HM4
	15-21AM2LM4	15-21AM2LM6	15-21AM2LM9	15-21AM2LM12	15-21AM2LM16	15-21AM2HM2	15-21AM2HM4
	10-21AM4LM4	10-21AM4LM6	10-21AM4LM9	10-21AM4LM12	10-21AM4LM16	10-21AM4HM2	10-21AM4HM4
	10-21AM6LM4	10-21AM6LM6	10-21AM6LM9	10-21AM6LM12	10-21AM6LM16	10-21AM6HM2	10-21AM6HM4
	20-21LM4LM4	20-21LM4LM6	10-21LM4LM9	20-21LM4LM12	20-21LM4LM16	20-21LM4HM2	20-21LM4HM4
	20-21LM4LM6	20-21LM6LM6	20-21LM6LM9	20-21LM6LM12	20-21LM6LM16	20-21LM6HM2	20-21LM6HM4
	20-21LM4LM9	20-21LM6LM9	20-21LM9LM9	20-21LM9LM12	20-21LM9LM16	20-21LM9HM2	20-21LM9HM4
	20-21LM4LM12	20-21LM6LM12	20-21LM9LM12	20-21LM12LM12	20-21LM12LM16	20-21LM12HM2	20-21LM12HM4
	20-21LM4LM16	20-21LM6LM16	20-21LM9LM16	20-21LM12LM16	20-21LM16LM16	20-21LM16HM2	20-21LM16HM4
	20-21LM4HM2	20-21LM6HM2	20-21LM9HM2	20-21LM12HM2	20-21LM16HM2	60-21HM2HM2	60-21HM2HM4
	20-21LM4HM4	20-21LM6HM4	20-21LM9HM4	20-21LM12HM4	20-21LM16HM4	60-21HM2HM4	60-21HM4HM4
	20-21LM4HM6	20-21LM6HM6	20-21LM9HM6	20-21LM12HM6	20-21LM16HM6	60-21HM2HM6	60-21HM4HM6
	20-21LM4HM9	20-21LM6HM9	20-21LM9HM9	20-21LM12HM9	20-21LM16HM9	60-21HM2HM9	60-21HM4HM9
	20-21LM4HM16	20-21LM6HM16	20-21LM9HM16	20-21LM12HM16	20-21LM16HM16	30-21HM2HM16	30-21HM4HM16
	20-21LM4XM4	20-21LM6XM4	20-21LM9XM4	20-21LM12XM4	20-21LM16XM4	60-21HM2XM4	60-21HM4XM4
	20-21LM4XM6	20-21LM6XM6	20-21LM9XM6	20-21LM12XM6	20-21LM16XM6	60-21HM2XM6	60-21HM4XM6
	20-21LM4NMA	20-21LM6NMA	20-21LM9NMA	20-21LM12NMA	20-21LM16NMA	30-21HM2NMA	30-21HM4NMA
	20-21LM4NMB	20-21LM6NMB	20-21LM9NMB	20-21LM12NMB	20-21LM16NMB	30-21HM2NMB	30-21HM4NMB
	20-21LM4NMC	20-21LM6NMC	20-21LM9NMC	20-21LM12NMC	20-21LM16NMC	30-21HM2NMC	30-21HM4NMC
	20-21LM4NMD	20-21LM6NMD	20-21LM9NMD	20-21LM12NMD	20-21LM16NMD	30-21HM2NMD	30-21HM4NMD
	10-21LM4NMF	10-21LM6NMF	10-21LM9NMF	10-21LM12NMF	10-21LM16NMF	10-21HM2NMF	10-21HM4NMF
	10-21LM4NMH	10-21LM6NMH	10-21LM9NMH	10-21LM12NMH	10-21LM16NMH	10-21HM2NMH	10-21HM4NMH

	XM6	NMA	NMB	NMC	NMD	NMF	NMH
	3/8" Ultra High Pressure	1/8" NPT Pipe	1/4" NPT Pipe	3/8" NPT Pipe	1/2" NPT Pipe	3/4" NPT Pipe	1" NPT Pipe
	15-21AM1XM6	15-21AM1NMA	15-21AM1NMB	15-21AM1NMC	15-21AM1NMD	10-21AM1NMF	10-21AM1NMH
	15-21AM2XM6	15-21AM2NMA	15-21AM2NMB	15-21AM2NMC	15-21AM2NMD	10-21AM2NMF	10-21AM2NMH
	10-21AM4XM6	10-21AM4NMA	10-21AM4NMB	10-21AM4NMC	10-21AM4NMD	10-21AM4NMF	10-21AM4NMH
	10-21AM6XM6	10-21AM6NMA	10-21AM6NMB	10-21AM6NMC	10-21AM6NMD	10-21AM6NMF	10-21AM6NMH
	20-21LM4XM6	20-21LM4NMA	20-21LM4NMB	20-21LM4NMC	20-21LM4NMD	10-21LM4NMF	10-21LM4NMH
	20-21LM6XM6	20-21LM6NMA	20-21LM6NMB	20-21LM6NMC	20-21LM6NMD	10-21LM6NMF	10-21LM6NMH
	20-21LM9XM6	20-21LM9NMA	20-21LM9NMB	20-21LM9NMC	20-21LM9NMD	10-21LM9NMF	10-21LM9NMH
	20-21LM12XM6	20-21LM12NMA	20-21LM12NMB	20-21LM12NMC	20-21LM12NMD	10-21LM12NMF	10-21LM12NMH
	20-21LM16XM6	20-21LM16NMA	20-21LM16NMB	20-21LM16NMC	20-21LM16NMD	10-21LM16NMF	10-21LM16NMH
	60-21HM2XM6	30-21HM2NMA	30-21HM2NMB	30-21HM2NMC	30-21HM2NMD	10-21HM2NMF	10-21HM2NMH
	60-21HM4XM6	30-21HM4NMA	30-21HM4NMB	30-21HM4NMC	30-21HM4NMD	10-21HM4NMF	10-21HM4NMH
	60-21HM6XM6	30-21HM6NMA	30-21HM6NMB	30-21HM6NMC	30-21HM6NMD	10-21HM6NMF	10-21HM6NMH
	60-21HM9XM6	30-21HM9NMA	30-21HM9NMB	30-21HM9NMC	30-21HM9NMD	10-21HM9NMF	10-21HM9NMH
	30-21HM16XM6	30-21HM16NMA	30-21HM16NMB	30-21HM16NMC	30-21HM16NMD	10-21HM16NMF	10-21HM16NMH
	100-21XM4XM6	30-21XM4NMA	30-21XM4NMB	30-21XM4NMC	30-21XM4NMD	10-21XM4NMF	10-21XM4NMH
	150-21XM6XM6	30-21XM6NMA	30-21XM6NMB	30-21XM6NMC	30-21XM6NMD	10-21XM6NMF	10-21XM6NMH
	30-21XM6NMA	15-21NMANMA	15-21NMANMA	15-21NMANMC	15-21NMANMD	10-21NMANMF	10-21NMANMH
	30-21XM6NMB	15-21NMANMB	15-21NMBNMB	15-21NMBNMC	15-21NMBNMD	10-21NMBNMF	10-21NMBNMH
	30-21XM6NMC	15-21NMANMC	15-21NMBNMC	15-21NMCNMC	15-21NMCNMD	10-21NMCNMF	10-21NMCNMH
	30-21XM6NMD	15-21NMANMD	15-21NMBNMD	15-21NMCNMD	15-21NMDNMD	10-21NMDNMF	10-21NMDNMH
	10-21XM6NMF	10-21NMANMF	10-21NMBNMF	10-21NMCNMF	10-21NMDNMF	10-21NMFNMF	10-21NMFNMH
	10-21XM6NMH	10-21NMANMH	10-21NMBNMH	10-21NMCNMH	10-21NMDNMH	10-21NMFNMH	10-21NMHNMH



## High Pressure Equipment



### Adapters: Female to Male

A complete range of adapters is offered for flexibility in going from tube to tube and from tube to pipe.

All standard adapter bodies are made from high tensile 316 stainless steel. Standard tubing glands and collars (sleeves) are provided with adapters unless otherwise specified.

### Female Taper Seal to Male Taper Seal

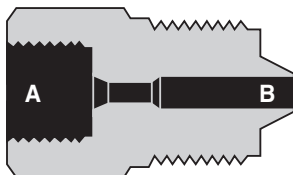

Catalog No.	Pressure Rating psi	Connections	A	B	Length	Hex Size
15-21AF1AM2	15,000	1/16" O.D. TUBE TO 1/8" TAPER SEAL	AF1	AM2	15/16"	5/8"
10-21AF1AM4	10,000	1/16" O.D. TUBE TO 1/4" TAPER SEAL	AF1	AM4	1 1/4"	3/4"
10-21AF1AM6	10,000	1/16" O.D. TUBE TO 3/8" TAPER SEAL	AF1	AM6	1 1/4"	3/4"
10-21AF2AM4	10,000	1/8" O.D. TUBE TO 1/4" TAPER SEAL	AF2	AM4	1 1/4"	3/4"
10-21AF2AM6	10,000	1/8" O.D. TUBE TO 3/8" TAPER SEAL	AF2	AM6	1 1/4"	3/4"

### Female Taper Seal to Male High Pressure

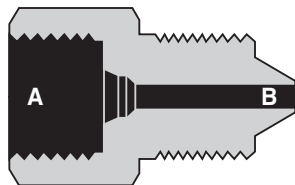

Catalog No.	Pressure Rating psi	Connections	A	B	Length	Hex Size
15-21AF1HM2	15,000	1/16" T.S. TO 1/8" H.P. MALE	AF1	HM2	7/8"	1 1/2"
15-21AF1HM4	15,000	1/16" T.S. TO 1/4" H.P. MALE	AF1	HM4	1 1/4"	5/8"
15-21AF1HM6	15,000	1/16" T.S. TO 3/8" H.P. MALE	AF1	HM6	1 3/4"	3/4"
15-21AF1HM9	15,000	1/16" T.S. TO 9/16" H.P. MALE	AF1	HM9	2 1/8"	1 1/8"
15-21AF2HM2	15,000	1/8" T.S. TO 1/8" H.P. MALE	AF2	HM2	1 1/8"	5/8"
15-21AF2HM4	15,000	1/8" T.S. TO 1/4" H.P. MALE	AF2	HM4	1 1/4"	5/8"
15-21AF2HM6	15,000	1/8" T.S. TO 3/8" H.P. MALE	AF2	HM6	1 3/4"	3/4"
15-21AF2HM9	15,000	1/8" T.S. TO 9/16" H.P. MALE	AF2	HM9	2 1/8"	1 1/8"
10-21AF4HM2	10,000	1/4" T.S. TO 1/8" H.P. MALE	AF4	HM2	1 7/16"	1"
10-21AF4HM4	10,000	1/4" T.S. TO 1/4" H.P. MALE	AF4	HM4	1 1/2"	1"
10-21AF4HM6	10,000	1/4" T.S. TO 3/8" H.P. MALE	AF4	HM6	1 5/8"	1"
10-21AF4HM9	10,000	1/4" T.S. TO 9/16" H.P. MALE	AF4	HM9	2 1/8"	1 1/8"
10-21AF6HM2	10,000	3/8" T.S. TO 1/8" H.P. MALE	AF6	HM2	1 1/2"	1"
10-21AF6HM4	10,000	3/8" T.S. TO 1/4" H.P. MALE	AF6	HM4	1 1/2"	1"
10-21AF6HM6	10,000	3/8" T.S. TO 3/8" H.P. MALE	AF6	HM6	1 3/4"	1"
10-21AF6HM9	10,000	3/8" T.S. TO 9/16" H.P. MALE	AF6	HM9	2 1/8"	1 1/8"



## Female to Male Adapters

### Female Taper Seal to Male Pipe

Catalog No.	Pressure Rating psi	Connections	A	B	Length	Hex Size
15-21AF1NMA	15,000	1/16" T.S. TO 1/8" NPT MALE	AF1	NMA	1"	1/2"
15-21AF1NMB	15,000	1/16" T.S. TO 1/4" NPT MALE	AF1	NMB	1 1/4"	5/8"
15-21AF1NMC	15,000	1/16" T.S. TO 3/8" NPT MALE	AF1	NMC	1 3/8"	3/4"
15-21AF1NMD	15,000	1/16" T.S. TO 1/2" NPT MALE	AF1	NMD	1 3/4"	1"
15-21AF1NMF	15,000	1/16" T.S. TO 3/4" NPT MALE	AF1	NMF	1 5/8"	1 3/8"
15-21AF1NMH	15,000	1/16" T.S. TO 1" NPT MALE	AF1	NMH	1 5/8"	1 3/8"
15-21AF2NMA	15,000	1/8" T.S. TO 1/8" NPT MALE	AF2	NMA	1 1/4"	3/4"
15-21AF2NMB	15,000	1/8" T.S. TO 1/4" NPT MALE	AF2	NMB	1 1/4"	5/8"
15-21AF2NMC	15,000	1/8" T.S. TO 3/8" NPT MALE	AF2	NMC	1 3/8"	3/4"
15-21AF2NMD	15,000	1/8" T.S. TO 1/2" NPT MALE	AF2	NMD	1 3/4"	1"
15-21AF2NMF	15,000	1/8" T.S. TO 3/4" NPT MALE	AF2	NMF	1 5/8"	1 3/8"
15-21AF2NMH	15,000	1/8" T.S. TO 1" NPT MALE	AF2	NMH	1 5/8"	1 3/8"
10-21AF4NMA	10,000	1/4" T.S. TO 1/8" NPT MALE	AF4	NMA	1 1/2"	1"
10-21AF4NMB	10,000	1/4" T.S. TO 1/4" NPT MALE	AF4	NMB	1 5/8"	1"
10-21AF4NMC	10,000	1/4" T.S. TO 3/8" NPT MALE	AF4	NMC	1 5/8"	1"
10-21AF4NMD	10,000	1/4" T.S. TO 1/2" NPT MALE	AF4	NMD	1 3/4"	1"
10-21AF4NMF	10,000	1/4" T.S. TO 3/4" NPT MALE	AF4	NMF	1 1/2"	1 3/8"
10-21AF4NMH	10,000	1/4" T.S. TO 1" NPT MALE	AF4	NMH	1 7/8"	1 3/8"
10-21AF6NMA	10,000	3/8" T.S. TO 1/8" NPT MALE	AF6	NMA	1 1/2"	1"
10-21AF6NMB	10,000	3/8" T.S. TO 1/4" NPT MALE	AF6	NMB	1 5/8"	1"
10-21AF6NMC	10,000	3/8" T.S. TO 3/8" NPT MALE	AF6	NMC	1 5/8"	1"
10-21AF6NMD	10,000	3/8" T.S. TO 1/2" NPT MALE	AF6	NMD	1 3/4"	1"
10-21AF6NMF	10,000	3/8" T.S. TO 3/4" NPT MALE	AF6	NMF	1 7/8"	1 3/8"
10-21AF6NMH	10,000	3/8" T.S. TO 1" NPT MALE	AF6	NMH	1 7/8"	1 3/8"

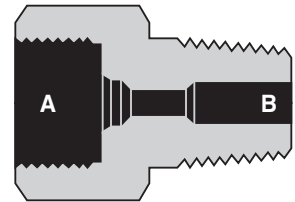

### Female High Pressure to Male High Pressure

Catalog No.	Pressure Rating psi	Connections	A	B	Length	Hex Size
60-21HF2HM4	60,000	1/8" O.D. TUBE TO 1/4" H.P.	HF2	HM4	1 1/4"	3/4"
60-21HF2HM6	60,000	1/8" O.D. TUBE TO 3/8" H.P.	HF2	HM6	1 3/4"	3/4"
60-21HF2HM9	60,000	1/8" O.D. TUBE TO 9/16" H.P.	HF2	HM9	2 1/8"	1 1/8"
60-21HF4HM2	60,000	1/4" O.D. TUBE TO 1/8" H.P.	HF4	HM2	1 3/8"	3/4"
60-21HF4HM6	60,000	1/4" O.D. TUBE TO 3/8" H.P.	HF4	HM6	1 3/4"	3/4"
60-21HF4HM9	60,000	1/4" O.D. TUBE TO 9/16" H.P.	HF4	HM9	2 1/8"	1 1/8"
60-21HF6HM2	60,000	1/4" O.D. TUBE TO 1/8" H.P.	HF6	HM2	1 1/2"	1"
60-21HF6HM4	60,000	3/8" O.D. TUBE TO 1/4" H.P.	HF6	HM4	1 1/2"	1"
60-21HF6HM9	60,000	3/8" O.D. TUBE TO 9/16" H.P.	HF6	HM9	2 1/8"	1 1/8"
60-21HF9HM4	60,000	9/16" O.D. TUBE TO 1/4" H.P.	HF9	HM4	1 3/4"	1 3/8"
60-21HF9HM6	60,000	9/16" O.D. TUBE TO 3/8" H.P.	HF9	HM6	1 7/8"	1 3/8"

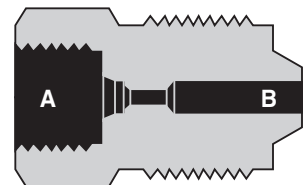



## High Pressure Equipment

### Female Medium Pressure to Male Medium Pressure

Catalog No.	Pressure Rating psi	Connections	A	B	Length	Hex Size
20-21LF4LM6	20,000	1/4" M.P. FEMALE to 3/8" M.P. MALE	LF4	LM6	1 3/4"	3/4"
20-21LF4LM9	20,000	1/4" M.P. FEMALE to 9/16" M.P. MALE	LF4	LM9	1 7/8"	7/8"
20-21LF6LM4	20,000	3/8" M.P. FEMALE to 1/4" M.P. MALE	LF6	LM4	1 3/4"	3/4"
20-21LF6LM9	20,000	3/8" M.P. FEMALE to 9/16" M.P. MALE	LF6	LM9	1 7/8"	7/8"
20-21LF9LM4	20,000	9/16" M.P. FEMALE to 1/4" M.P. MALE	LF9	LM4	2 1/8"	1"
20-21LF9LM6	20,000	9/16" M.P. FEMALE to 3/8" M.P. MALE	LF9	LM6	2 1/8"	1"
20-21LF12LM4	20,000	3/4" M.P. FEMALE to 1/4" M.P. MALE	LF12	LM4	2 1/4"	1 3/8"
20-21LF12LM6	20,000	3/4" M.P. FEMALE to 3/8" M.P. MALE	LF12	LM6	2 3/8"	1 3/8"
20-21LF12LM9	20,000	3/4" M.P. FEMALE to 9/16" M.P. MALE	LF12	LM9	2 7/8"	1 3/8"
20-21LF12LM16	20,000	3/4" M.P. FEMALE to 1" M.P. MALE	LF12	LM16	3 3/4"	1 3/8"
20-21LF4LM12	20,000	1/4" M.P. FEMALE to 3/4" M.P. MALE	LF4	LM12	2"	1 1/8"
20-21LF6LM12	20,000	3/8" M.P. FEMALE to 3/4" M.P. MALE	LF6	LM12	2"	1 1/8"
20-21LF9LM12	20,000	9/16" M.P. FEMALE to 3/4" M.P. MALE	LF9	LM12	2 1/2"	1 1/8"
20-21LF16LM4	20,000	1" M.P. FEMALE to 1/4" M.P. MALE	LF16-30	LM4	2 3/4"	1 3/4"
20-21LF16LM6	20,000	1" M.P. FEMALE to 3/8" M.P. MALE	LF16-30	LM6	2 7/8"	1 3/4"
20-21LF16LM9	20,000	1" M.P. FEMALE to 9/16" M.P. MALE	LF16-30	LM9	3"	1 3/4"
20-21LF16LM12	20,000	1" M.P. FEMALE to 3/4" M.P. MALE	LF16-30	LM12	3 1/4"	1 3/4"
20-21LF4LM16	20,000	1/4" M.P. FEMALE to 1" M.P. MALE	LF4	LM16	3"	1"
20-21LF6LM16	20,000	3/8" M.P. FEMALE to 1" M.P. MALE	LF6	LM16	3 1/8"	1"
20-21LF9LM16	20,000	9/16" M.P. FEMALE to 1" M.P. MALE	LF9	LM16	3 3/8"	1"

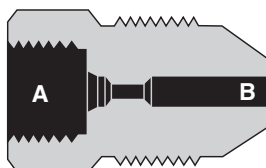

### Female Medium Pressure to Male High Pressure

Catalog No.	Pressure Rating psi	Connections	A	B	Length	Hex Size
20-21LF4HM4	20,000	1/4" M.P. FEMALE to 1/4" H.P. MALE	LF4	HM4	1 3/8"	3/4"
20-21LF4HM6	20,000	1/4" M.P. FEMALE to 3/8" H.P. MALE	LF4	HM6	1 3/4"	3/4"
20-21LF4HM9	20,000	1/4" M.P. FEMALE to 9/16" H.P. MALE	LF4	HM9	2 1/8"	1 1/8"
20-21LF6HM4	20,000	3/8" M.P. FEMALE to 1/4" H.P. MALE	LF6	HM4	1 3/4"	3/4"
20-21LF6HM6	20,000	3/8" M.P. FEMALE to 3/8" H.P. MALE	LF6	HM6	1 3/4"	3/4"
20-21LF6HM9	20,000	3/8" M.P. FEMALE to 9/16" H.P. MALE	LF6	HM9	2 1/8"	1 1/8"
20-21LF9HM4	20,000	9/16" M.P. FEMALE to 1/4" H.P. MALE	LF9	HM4	1 7/8"	1"
20-21LF9HM6	20,000	9/16" M.P. FEMALE to 3/8" H.P. MALE	LF9	HM6	2 1/8"	1"
20-21LF9HM9	20,000	9/16" M.P. FEMALE to 9/16" H.P. MALE	LF9	HM9	2 1/8"	1 1/8"
20-21LF12HM4	20,000	3/4" M.P. FEMALE to 1/4" H.P. MALE	LF12	HM4	2 1/2"	1 3/8"
20-21LF12HM6	20,000	3/4" M.P. FEMALE to 3/8" H.P. MALE	LF12	HM6	2 3/8"	1 3/8"
20-21LF12HM9	20,000	3/4" M.P. FEMALE to 9/16" H.P. MALE	LF12	HM9	2 5/8"	1 3/8"
* 20-21LF16HM4	20,000	1" M.P. FEMALE to 1/4" H.P. MALE	LF16	HM4	2 5/8"	1 3/4"
* 20-21LF16HM6	20,000	1" M.P. FEMALE to 3/8" H.P. MALE	LF16	HM6	2 7/8"	1 3/4"
* 20-21LF16HM9	20,000	1" M.P. FEMALE to 9/16" H.P. MALE	LF16	HM9	3 1/8"	1 3/4"

\* Can be rated to 30,000 psi if used with 1" O.D. x 7/16" I.D. tubing.

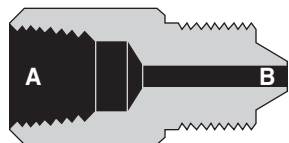

## Female to Male Adapters

### Female Medium Pressure to Male Pipe

Catalog No.	Pressure Rating psi	Connections	A	B	Length	Hex Size
20-21LF4NMA	15,000	1/4" M.P. FEMALE to 1/8" NPT MALE	LF4	NMA	1 7/16"	3/4"
20-21LF4NMB	15,000	1/4" M.P. FEMALE to 1/4" NPT MALE	LF4	NMB	1 5/8"	3/4"
20-21LF4NMC	15,000	1/4" M.P. FEMALE to 3/8" NPT MALE	LF4	NMC	1 5/8"	3/4"
20-21LF4NMD	15,000	1/4" M.P. FEMALE to 1/2" NPT MALE	LF4	NMD	1 3/4"	1"
10-21LF4NMF	10,000	1/4" M.P. FEMALE to 3/4" NPT MALE	LF4	NMF	1 7/8"	1 3/8"
10-21LF4NMH	10,000	1/4" M.P. FEMALE to 1" NPT MALE	LF4	NMH	1 7/8"	1 3/8"
20-21LF6NMA	15,000	3/8" M.P. FEMALE to 1/8" NPT MALE	LF6	NMA	1 7/16"	3/4"
20-21LF6NMB	15,000	3/8" M.P. FEMALE to 1/4" NPT MALE	LF6	NMB	1 5/8"	3/4"
20-21LF6NMC	15,000	3/8" M.P. FEMALE to 3/8" NPT MALE	LF6	NMC	1 5/8"	3/4"
20-21LF6NMD	15,000	3/8" M.P. FEMALE to 1/2" NPT MALE	LF6	NMD	1 3/4"	1"
10-21LF6NMF	10,000	3/8" M.P. FEMALE to 3/4" NPT MALE	LF6	NMF	1 7/8"	1 3/8"
10-21LF6NMH	10,000	3/8" M.P. FEMALE to 1" NPT MALE	LF6	NMH	1 7/8"	1 3/8"
20-21LF9NMA	15,000	9/16" M.P. FEMALE to 1/8" NPT MALE	LF9	NMA	1 7/8"	1"
20-21LF9NMB	15,000	9/16" M.P. FEMALE to 1/4" NPT MALE	LF9	NMB	1 7/8"	1"
20-21LF9NMC	15,000	9/16" M.P. FEMALE to 3/8" NPT MALE	LF9	NMC	1 7/8"	1"
20-21LF9NMD	15,000	9/16" M.P. FEMALE to 1/2" NPT MALE	LF9	NMD	1 7/8"	1"
10-21LF9NMF	10,000	9/16" M.P. FEMALE to 3/4" NPT MALE	LF9	NMF	1 7/8"	1 3/8"
10-21LF9NMH	10,000	9/16" M.P. FEMALE to 1" NPT MALE	LF9	NMH	1 7/8"	1 3/8"
20-21LF12NMA	15,000	3/4" M.P. FEMALE to 1/8" NPT MALE	LF12	NMA	2 1/2"	1 3/8"
20-21LF12NMB	15,000	3/4" M.P. FEMALE to 1/4" NPT MALE	LF12	NMB	2 1/2"	1 3/8"
20-21LF12NMC	15,000	3/4" M.P. FEMALE to 3/8" NPT MALE	LF12	NMC	2 1/2"	1 3/8"
20-21LF12NMD	15,000	3/4" M.P. FEMALE to 1/2" NPT MALE	LF12	NMD	2 1/2"	1 3/8"
10-21LF12NMF	10,000	3/4" M.P. FEMALE to 3/4" NPT MALE	LF12	NMF	2 1/2"	1 3/8"
10-21LF12NMH	10,000	3/4" M.P. FEMALE to 1" NPT MALE	LF12	NMH	2 1/2"	1 3/8"
20-21LF16NMA	15,000	1" M.P. FEMALE to 1/8" NPT MALE	LF16-30	NMA	2 1/2"	1 3/8"
20-21LF16NMB	15,000	1" M.P. FEMALE to 1/4" NPT MALE	LF16-30	NMB	2 1/2"	1 3/8"
20-21LF16NMC	15,000	1" M.P. FEMALE to 3/8" NPT MALE	LF16-30	NMC	2 1/2"	1 3/8"
20-21LF16NMD	15,000	1" M.P. FEMALE to 1/2" NPT MALE	LF16-30	NMD	2 1/2"	1 3/8"
10-21LF16NMF	10,000	1" M.P. FEMALE to 3/4" NPT MALE	LF16-30	NMF	2 1/2"	1 3/8"
10-21LF16NMH	10,000	1" M.P. FEMALE to 1" NPT MALE	LF16-30	NMH	2 1/2"	1 3/8"

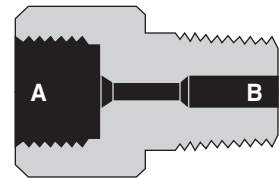



## High Pressure Equipment

### Female Pipe to Male High Pressure

Catalog No.	Pressure Rating psi	Connections	A	B	Length	Hex Size
30-21NFAHM2	15,000	1/8" NPT TO 1/8" H.P. MALE	NFA	HM2	1 5/8"	3/4"
30-21NFBHM2	15,000	1/4" NPT TO 1/8" H.P. MALE	NFB	HM2	1 5/8"	3/4"
30-21NFCM2	15,000	3/8" NPT TO 1/8" H.P. MALE	NFC	HM2	1 3/4"	1"
30-21NFAHM4	15,000	1/8" NPT TO 1/4" H.P. MALE	NFA	HM4	1 5/8"	3/4"
30-21NFBHM4	15,000	1/4" NPT TO 1/4" H.P. MALE	NFB	HM4	1 3/4"	3/4"
30-21NFCM4	15,000	3/8" NPT TO 1/4" H.P. MALE	NFC	HM4	1 3/4"	1"
30-21NFDHM4	15,000	1/2" NPT TO 1/4" H.P. MALE	NFD	HM4	2 1/8"	1 1/8"
30-21NFAHM6	15,000	1/8" NPT TO 3/8" H.P. MALE	NFA	HM6	1 5/8"	3/4"
30-21NFBHM6	15,000	1/4" NPT TO 3/8" H.P. MALE	NFB	HM6	1 3/4"	3/4"
30-21NFCM6	15,000	3/8" NPT TO 3/8" H.P. MALE	NFC	HM6	1 3/4"	1"
30-21NFDHM6	15,000	1/2" NPT TO 3/8" H.P. MALE	NFD	HM6	2 1/8"	1 1/8"
10-21NFFHM6	10,000	3/4" NPT TO 3/8" H.P. MALE	NFF	HM6	2 1/2"	1 5/8"
30-21NFAHM9	15,000	1/8" NPT TO 9/16" H.P. MALE	NFA	HM9	2 1/8"	1 1/8"
30-21NFBHM9	15,000	1/4" NPT TO 9/16" H.P. MALE	NFB	HM9	2 1/8"	1 1/8"
30-21NFCM9	15,000	3/8" NPT TO 9/16" H.P. MALE	NFC	HM9	2 1/8"	1 1/8"
30-21NFDHM9	15,000	1/2" NPT TO 9/16" H.P. MALE	NFD	HM9	2 1/8"	1 1/8"
10-21NFFHM9	10,000	3/4" NPT TO 9/16" H.P. MALE	NFF	HM9	2 1/4"	1 3/8"
10-21NFH9M9	10,000	1" NPT TO 9/16" H.P. MALE	NFH	HM9	2"	1 7/8"

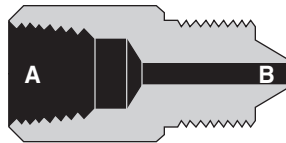

### Female High Pressure to Male Medium Pressure

Catalog No.	Pressure Rating psi	Connections	A	B	Length	Hex Size
20-21HF4LM4	20,000	1/4" H.P. FEMALE TO 1/4" M.P. MALE	HF4	LM4	1 3/4"	3/4"
20-21HF4LM6	20,000	1/4" H.P. FEMALE TO 3/8" M.P. MALE	HF4	LM6	1 3/4"	3/4"
20-21HF4LM9	20,000	1/4" H.P. FEMALE TO 9/16" M.P. MALE	HF4	LM9	1 7/8"	7/8"
20-21HF6LM4	20,000	3/8" H.P. FEMALE TO 1/4" M.P. MALE	HF6	LM4	1 7/8"	1"
20-21HF6LM6	20,000	3/8" H.P. FEMALE TO 3/8" M.P. MALE	HF6	LM6	1 7/8"	1"
20-21HF6LM9	20,000	3/8" H.P. FEMALE TO 9/16" M.P. MALE	HF6	LM9	2"	1"
20-21HF9LM4	20,000	9/16" H.P. FEMALE TO 1/4" M.P. MALE	HF9	LM4	2 1/8"	1 3/8"
20-21HF9LM6	20,000	9/16" H.P. FEMALE TO 3/8" M.P. MALE	HF9	LM6	2 1/8"	1 3/8"
20-21HF9LM9	20,000	9/16" H.P. FEMALE TO 9/16" M.P. MALE	HF9	LM9	2 3/8"	1 3/8"
20-21HF4LM12	20,000	1/4" H.P. FEMALE TO 3/4" M.P. MALE	HF4	LM12	2 1/4"	1 1/8"
20-21HF6LM12	20,000	3/8" H.P. FEMALE TO 3/4" M.P. MALE	HF6	LM12	2 1/4"	1 1/8"
20-21HF9LM12	20,000	9/16" H.P. FEMALE TO 3/4" M.P. MALE	HF9	LM12	2 1/2"	1 3/8"
20-21HF4LM16	20,000	1/4" H.P. FEMALE TO 1" M.P. MALE	HF4	LM16	3"	1"
20-21HF6LM16	20,000	3/8" H.P. FEMALE TO 1" M.P. MALE	HF6	LM16	3 1/4"	1"
20-21HF9LM16	20,000	9/16" H.P. FEMALE TO 1" M.P. MALE	HF9	LM16	3 5/8"	1 3/8"
20-21HF4LM16	20,000	1/4" H.P. FEMALE TO 1" M.P. MALE	HF4	LM16-30	3"	1"
20-21HF6LM16	20,000	3/8" H.P. FEMALE TO 1" M.P. MALE	HF6	LM16-30	3 1/4"	1"
20-21HF9LM16	20,000	9/16" H.P. FEMALE TO 1" M.P. MALE	HF9	LM16-30	3 5/8"	1 3/8"

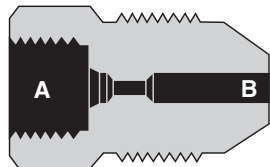

## Female to Male Adapters

### Female High Pressure to Male Pipe

Catalog No.	Pressure Rating psi	Connections	A	B	Length	Hex Size
30-21HF2NMA	15,000	1/8" H.P. TO 1/8" NPT MALE	HF2	NMA	1 1/4"	5/8"
30-21HF2NMB	15,000	1/8" H.P. TO 1/4" NPT MALE	HF2	NMB	1 1/4"	5/8"
30-21HF2NMC	15,000	1/8" H.P. TO 3/8" NPT MALE	HF2	NMC	1 3/8"	3/4"
30-21HF2NMD	15,000	1/8" H.P. TO 1/2" NPT MALE	HF2	NMD	1 1/2"	1"
10-21HF2NMF	10,000	1/8" H.P. TO 3/4" NPT MALE	HF2	NMF	1 3/4"	1 3/8"
10-21HF2NMH	10,000	1/8" H.P. TO 1" NPT MALE	HF2	NMH	1 3/4"	1 3/8"
30-21HF4NMA	15,000	1/4" H.P. TO 1/8" NPT MALE	HF4	NMA	1 1/4"	3/4"
30-21HF4NMB	15,000	1/4" H.P. TO 1/4" NPT MALE	HF4	NMB	1 3/8"	3/4"
30-21HF4NMC	15,000	1/4" H.P. TO 3/8" NPT MALE	HF4	NMC	1 3/8"	3/4"
30-21HF4NMD	15,000	1/4" H.P. TO 1/2" NPT MALE	HF4	NMD	1 3/4"	1"
10-21HF4NMF	10,000	1/4" H.P. TO 3/4" NPT MALE	HF4	NMF	1 3/4"	1 3/8"
10-21HF4NMH	10,000	1/4" H.P. TO 1" NPT MALE	HF4	NMH	1 5/8"	1 3/8"
30-21HF6NMA	15,000	3/8" H.P. TO 1/8" NPT MALE	HF6	NMA	1 1/2"	1"
30-21HF6NMB	15,000	3/8" H.P. TO 1/4" NPT MALE	HF6	NMB	1 5/8"	1"
30-21HF6NMC	15,000	3/8" H.P. TO 3/8" NPT MALE	HF6	NMC	1 5/8"	1"
30-21HF6NMD	15,000	3/8" H.P. TO 1/2" NPT MALE	HF6	NMD	1 3/4"	1"
10-21HF6NMF	10,000	3/8" H.P. TO 3/4" NPT MALE	HF6	NMF	1 7/8"	1 3/8"
10-21HF6NMH	10,000	3/8" H.P. TO 1" NPT MALE	HF6	NMH	1 7/8"	1 3/8"
30-21HF9NMA	15,000	9/16" H.P. TO 1/8" NPT MALE	HF9	NMA	1 1/2"	1 3/8"
30-21HF9NMB	15,000	9/16" H.P. TO 1/4" NPT MALE	HF9	NMB	1 5/8"	1 3/8"
30-21HF9NMC	15,000	9/16" H.P. TO 3/8" NPT MALE	HF9	NMC	1 3/4"	1 3/8"
30-21HF9NMD	15,000	9/16" H.P. TO 1/2" NPT MALE	HF9	NMD	1 7/8"	1 3/8"
10-21HF9NMF	10,000	9/16" H.P. TO 3/4" NPT MALE	HF9	NMF	1 7/8"	1 3/8"
10-21HF9NMH	10,000	9/16" H.P. TO 1" NPT MALE	HF9	NMH	2"	1 3/8"

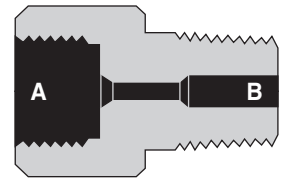

### Female Pipe to Male Taper Seal

Catalog No.	Pressure Rating psi	Connections	A	B	Hex Length	Size
15-21NFAAM2	15,000	1/8" FNPT TO 1/8" MALE T.S.	NFA	AM2	1 1/2"	5/8"
15-21NFBAM2	15,000	1/4" FNPT TO 1/8" MALE T.S.	NFB	AM2	1 5/8"	3/4"
15-21NFCAM2	15,000	3/8" FNPT TO 1/8" MALE T.S.	NFC	AM2	1 3/4"	1"
10-21NFAAM4	10,000	1/8" FNPT TO 1/4" MALE T.S.	NFA	AM4	1 3/4"	7/8"
10-21NFBAM4	10,000	1/4" FNPT TO 1/4" MALE T.S.	NFB	AM4	1 3/4"	1"
10-21NFCAM4	10,000	3/8" FNPT TO 1/4" MALE T.S.	NFC	AM4	1 3/4"	1"
10-21NFDAM4	10,000	1/2" FNPT TO 1/4" MALE T.S.	NFD	AM4	2 1/8"	1 1/8"
10-21NFAAM6	10,000	1/8" FNPT TO 3/8" MALE T.S.	NFA	AM6	2"	1"
10-21NFBAM6	10,000	1/4" FNPT TO 3/8" MALE T.S.	NFB	AM6	2"	1"
10-21NFCAM6	10,000	3/8" FNPT TO 3/8" MALE T.S.	NFC	AM6	2"	1"
10-21NFDAM6	10,000	1/2" FNPT TO 3/8" MALE T.S.	NFD	AM6	2 1/8"	1 1/8"

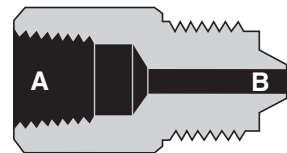





## High Pressure Equipment

### Female Pipe to Male Medium Pressure

Catalog No.	Pressure Rating psi	Connections	A	B	Length	Hex Size
20-21NFALM4	15,000	1/8" N.P.T. FEMALE to 1/4" M.P. MALE	NFA	LM4	1 3/4"	3/4"
20-21NFBLM4	15,000	1/4" N.P.T. FEMALE to 1/4" M.P. MALE	NFB	LM4	1 3/4"	3/4"
20-21NFCLM4	15,000	3/8" N.P.T. FEMALE to 1/4" M.P. MALE	NFC	LM4	2"	1"
20-21NFDLM4	15,000	1/2" N.P.T. FEMALE to 1/4" M.P. MALE	NFD	LM4	2 1/8"	1 1/8"
10-21NFFLM4	10,000	3/4" N.P.T. FEMALE to 1/4" M.P. MALE	NFF	LM4	2 3/8"	1 3/8"
20-21NFALM6	15,000	1/8" N.P.T. FEMALE to 3/8" M.P. MALE	NFA	LM6	1 7/8"	3/4"
20-21NFBLM6	15,000	1/4" N.P.T. FEMALE to 3/8" M.P. MALE	NFB	LM6	1 7/8"	3/4"
20-21NFCLM6	15,000	3/8" N.P.T. FEMALE to 3/8" M.P. MALE	NFC	LM6	2 1/8"	1"
20-21NFDLM6	15,000	1/2" N.P.T. FEMALE to 3/8" M.P. MALE	NFD	LM6	2 1/4"	1 1/8"
10-21NFFLM6	10,000	3/4" N.P.T. FEMALE to 3/8" M.P. MALE	NFF	LM6	2 1/2"	1 3/8"
10-21NFHLM6	10,000	1" N.P.T. FEMALE to 3/8" M.P. MALE	NFH	LM6	2 7/8"	1 7/8"
20-21NFALM9	15,000	1/8" N.P.T. FEMALE to 9/16" M.P. MALE	NFA	LM9	1 7/8"	7/8"
20-21NFBLM9	15,000	1/4" N.P.T. FEMALE to 9/16" M.P. MALE	NFB	LM9	1 7/8"	7/8"
20-21NFCLM9	15,000	3/8" N.P.T. FEMALE to 9/16" M.P. MALE	NFC	LM9	2 1/4"	1"
20-21NFDLM9	15,000	1/2" N.P.T. FEMALE to 9/16" M.P. MALE	NFD	LM9	2 3/8"	1 1/8"
10-21NFFLM9	10,000	3/4" N.P.T. FEMALE to 9/16" M.P. MALE	NFF	LM9	2 5/8"	1 3/8"
10-21NFHLM9	10,000	1" N.P.T. FEMALE to 9/16" M.P. MALE	NFH	LM9	3"	1 7/8"
20-21NFALM12	15,000	1/8" N.P.T. FEMALE to 3/4" M.P. MALE	NFA	LM12	2"	1 1/8"
20-21NFBLM12	15,000	1/4" N.P.T. FEMALE to 3/4" M.P. MALE	NFB	LM12	2"	1 1/8"
20-21NFCLM12	15,000	3/8" N.P.T. FEMALE to 3/4" M.P. MALE	NFC	LM12	2"	1 1/8"
20-21NFDLM12	15,000	1/2" N.P.T. FEMALE to 3/4" M.P. MALE	NFD	LM12	2 1/2"	1 1/8"
10-21NFFLM12	10,000	3/4" N.P.T. FEMALE to 3/4" M.P. MALE	NFF	LM12	2 3/4"	1 1/2"
10-21NFHLM12	10,000	1" N.P.T. FEMALE to 3/4" M.P. MALE	NFH	LM12	3"	1 7/8"
20-21NFALM16	15,000	1/8" N.P.T. FEMALE to 1" M.P. MALE	NFA	LM16	3"	1"
20-21NFBLM16	15,000	1/4" N.P.T. FEMALE to 1" M.P. MALE	NFB	LM16	3"	1"
20-21NFCLM16	15,000	3/8" N.P.T. FEMALE to 1" M.P. MALE	NFC	LM16	3"	1"
20-21NFDLM16	15,000	1/2" N.P.T. FEMALE to 1" M.P. MALE	NFD	LM16	3 3/4"	1 1/8"
10-21NFFLM16	10,000	3/4" N.P.T. FEMALE to 1" M.P. MALE	NFF	LM16	4 1/8"	1 1/2"
10-21NFHLM16	10,000	1" N.P.T. FEMALE to 1" M.P. MALE	NFH	LM16	4 3/8"	1 7/8"

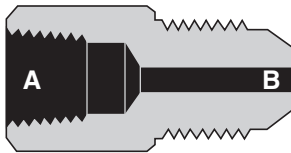

# Male to Male Adapters

## Adapters: Male to Male

Male to Male Adapters are available in the most commonly used sizes as listed below. These adapters permit the user to convert female connections to male connections, and are especially useful in confined installations or where rigidity is required. **Standard material** is high tensile Type 316 stainless steel.



### Male Taper Seal to Male Taper Seal

Catalog No.	Pressure Rating psi	Connections	A	B	Length	Hex Size
15-21AM1AM1	15,000	1/16" T.S. to 1/16" T.S.	AM1	AM1	1 3/8"	1/2"
15-21AM2AM2	15,000	1/8" T.S. to 1/8" T.S.	AM2	AM2	1 5/8"	5/8"
10-21AM2AM4	10,000	1/8" T.S. to 1/8" T.S.	AM2	AM4	1 7/8"	7/8"
10-21AM4AM4	10,000	1/4" T.S. to 1/4" T.S.	AM4	AM4	2 1/8"	7/8"
10-21AM4AM6	10,000	1/4" T.S. to 3/8" T.S.	AM4	AM6	2 1/8"	3/4"
10-21AM6AM6	10,000	3/8" T.S. to 3/8" T.S.	AM6	AM6	2 1/8"	3/4"



### Male Taper Seal to Male Medium Pressure

Catalog No.	Pressure Rating psi	Connections	A	B	Length	Hex Size
10-21AM4LM4	10,000	1/4" T.S. to 1/4" M.P.	AM4	LM4	2 1/8"	7/8"
10-21AM4LM6	10,000	1/4" T.S. to 3/8" M.P.	AM4	LM6	2 3/16"	7/8"
10-21AM4LM9	10,000	1/4" T.S. to 9/16" M.P.	AM4	LM9	2 3/8"	7/8"
10-21AM6LM4	10,000	3/8" T.S. to 1/4" M.P.	AM6	LM4	2 1/8"	7/8"
10-21AM6LM6	10,000	3/8" T.S. to 3/8" M.P.	AM6	LM6	2 3/16"	7/8"
10-21AM6LM9	10,000	3/8" T.S. to 9/16" M.P.	AM6	LM9	2 3/8"	7/8"
15-21AM2LM4	15,000	1/8" T.S. to 1/4" M.P.	AM2	LM4	1 7/8"	1/2"
15-21AM2LM6	15,000	1/8" T.S. to 3/8" M.P.	AM2	LM6	2"	5/8"
15-21AM2LM9	15,000	1/8" T.S. to 9/16" M.P.	AM2	LM9	2 1/8"	7/8"

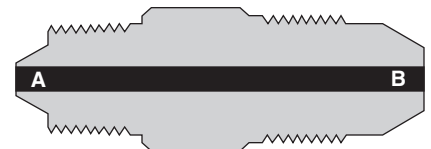

### Male Taper Seal to Male Pipe

Catalog No.	Pressure Rating psi	Connections	A	B	Length	Hex Size
15-21AM1NMA	15,000	1/16" T.S. to 1/8" NPT MALE	AM1	NMA	1 7/16"	1/2"
15-21AM1NMB	15,000	1/16" T.S. to 1/4" NPT MALE	AM1	NMB	1 9/16"	5/8"
15-21AM2NMA	15,000	1/8" T.S. to 1/8" NPT MALE	AM2	NMA	1 5/8"	1/2"
15-21AM2NMB	15,000	1/8" T.S. to 1/4" NPT MALE	AM2	NMB	1 3/4"	5/8"
15-21AM4NMB	15,000	1/4" T.S. to 1/4" NPT MALE	AM4	NMB	2"	3/4"





## High Pressure Equipment

### Male Taper Seal to Male High Pressure



Catalog No.	Pressure Rating psi	Connections	A	B	Length	Hex Size
15-21AM2HM2	15,000	1/8" T.S. to 1/8" H.P.	AM2	HM2	1 9/16"	5/8"
15-21AM2HM4	15,000	1/8" T.S. to 1/4" H.P.	AM2	HM4	1 5/8"	3/4"
10-21AM4HM4	10,000	1/4" T.S. to 1/4" H.P.	AM4	HM4	2"	3/4"

### Male Medium Pressure to Male High Pressure



Catalog No.	Pressure Rating psi	Connections	A	B	Length	Hex Size
20-21LM4HM2	20,000	1/4" M.P. to 1/8" H.P.	LM4	HM2	1 7/8"	5/8"
20-21LM4HM9	20,000	1/4" M.P. to 9/16" H.P.	LM4	HM9	2 3/8"	1 1/8"
20-21LM9HM4	20,000	9/16" M.P. to 1/4" H.P.	LM9	HM4	2 1/4"	7/8"
20-21LM9HM9	20,000	9/16" M.P. to 9/16" H.P.	LM9	HM9	2 5/8"	1 1/8"
20-21LM6HM4	20,000	3/8" M.P. to 1/4" H.P.	LM6	HM4	2 1/8"	5/8"
20-21LM6HM9	20,000	3/8" M.P. to 9/16" H.P.	LM6	HM9	2 1/2"	1 1/8"

### Male Medium Pressure to Male Pipe (NPT)



Catalog No.	Pressure Rating psi	Connections	A	B	Length	Hex Size
20-21LM4NMB	15,000	1/4" M.P. to 1/4" NPT MALE	LM4	NMB	2"	5/8"
20-21LM4NMD	15,000	1/4" M.P. to 1/2" NPT MALE	LM4	NMD	2 1/8"	7/8"
20-21LM6NMB	15,000	3/8" M.P. to 1/4" NPT MALE	LM6	NMB	2 1/16"	3/4"
20-21LM6NMC	15,000	3/8" M.P. to 3/8" NPT MALE	LM6	NMC	2 1/16"	3/4"
20-21LM6NMD	15,000	3/8" M.P. to 1/2" NPT MALE	LM6	NMD	2 3/16"	7/8"
20-21LM9NMA	15,000	9/16" M.P. to 1/8" NPT MALE	LM9	NMA	2 1/8"	7/8"
20-21LM9NMB	15,000	9/16" M.P. to 1/4" NPT MALE	LM9	NMB	2 1/4"	7/8"
20-21LM9NMC	15,000	9/16" M.P. to 3/8" NPT MALE	LM9	NMC	2 1/4"	7/8"
20-21LM9NMD	15,000	9/16" M.P. to 1/2" NPT MALE	LM9	NMD	2 3/8"	7/8"
10-21LM9NMF	10,000	9/16" M.P. to 3/4" NPT MALE	LM9	NMF	2 5/8"	1 1/8"
10-21LM9NMH	10,000	9/16" M.P. to 1" NPT MALE	LM9	NMH	2 5/8"	1 3/8"
20-21LM12NMA	15,000	3/4" M.P. to 1/8" NPT MALE	LM12	NMA	2 3/8"	1 1/8"
20-21LM12NMB	15,000	3/4" M.P. to 1/4" NPT MALE	LM12	NMB	2 1/2"	1 1/8"
20-21LM12NMC	15,000	3/4" M.P. to 3/8" NPT MALE	LM12	NMC	2 1/2"	1 1/8"
20-21LM12NMD	15,000	3/4" M.P. to 1/2" NPT MALE	LM12	NMD	2 5/8"	1 1/8"
10-21LM12NMF	10,000	3/4" M.P. to 3/4" NPT MALE	LM12	NMF	2 3/4"	1 1/8"
10-21LM12NMH	10,000	3/4" M.P. to 1" NPT MALE	LM12	NMH	3"	1 3/8"
20-21LM16NMA	15,000	1" M.P. to 1/8" NPT MALE	LM16	NMA	3 5/8"	1"
20-21LM16NMB	15,000	1" M.P. to 1/4" NPT MALE	LM16	NMB	3 3/4"	1"
20-21LM16NMC	15,000	1" M.P. to 3/8" NPT MALE	LM16	NMC	3 3/4"	1"
20-21LM16NMD	15,000	1" M.P. to 1/2" NPT MALE	LM16	NMD	3 7/8"	1"
10-21LM16NMF	10,000	1" M.P. to 3/4" NPT MALE	LM16	NMF	3 7/8"	1 1/8"
10-21LM16NMH	10,000	1" M.P. to 1" NPT MALE	LM16	NMH	4"	1 3/8"

# Male to Male Adapters

## Male Medium Pressure to Male Medium Pressure

Catalog No.	Pressure Rating psi	Connections	A	B	Length	Hex Size
20-21LM4LM4	20,000	1/4" M.P. to 1/4" M.P.	LM4	LM4	2"	5/8"
20-21LM4LM6	20,000	1/4" M.P. to 3/8" M.P.	LM4	LM4	2 1/8"	3/4"
20-21LM6LM6	20,000	3/8" M.P. to 3/8" M.P.	LM6	LM6	2 1/4"	3/4"
20-21LM6LM9	20,000	3/8" M.P. to 9/16" M.P.	LM6	LM6	2 1/2"	7/8"
20-21LM9LM9	20,000	9/16" M.P. to 9/16" M.P.	LM9	LM9	2 5/8"	7/8"
20-21LM4LM12	20,000	1/4" M.P. to 3/4" M.P.	LM4	LM12	2 1/2"	1 1/8"
20-21LM6LM12	20,000	3/8" M.P. to 3/4" M.P.	LM6	LM12	2 5/8"	1 1/8"
20-21LM9LM12	20,000	9/16" M.P. to 3/4" M.P.	LM9	LM12	2 7/8"	1 1/8"
20-21LM4LM16	20,000	1/4" M.P. to 1" M.P.	LM4	LM16	3 5/8"	1"
20-21LM6LM16	20,000	3/8" M.P. to 1" M.P.	LM6	LM16	3 3/4"	1"
20-21LM9LM16	20,000	9/16" M.P. to 1" M.P.	LM9	LM16	4"	1"
20-21LM12LM12	20,000	3/4" M.P. to 3/4" M.P.	LM12	LM12	3"	1 1/8"
20-21LM12LM16	20,000	3/4" M.P. to 1" M.P.	LM12	LM12	4 1/4"	1 1/8"

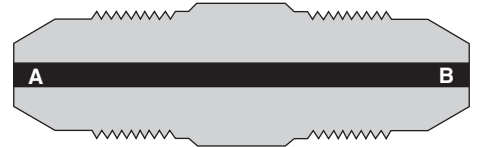

## Male High Pressure to Male Pipe (NPT)

Catalog No.	Pressure Rating psi	Connections	A	B	Length	Hex Size
30-21HM2NMA	15,000	1/8" H.P. to 1/8" NPT MALE	HM2	NMA	1 5/8"	1/2"
30-21HM2NMB	15,000	1/8" H.P. to 1/4" NPT MALE	HM2	NMB	1 3/4"	5/8"
30-21HM4NMA	15,000	1/4" H.P. to 1/8" NPT MALE	HM4	NMA	1 7/8"	5/8"
30-21HM4NMB	15,000	1/4" H.P. to 1/4" NPT MALE	HM4	NMB	2"	5/8"
30-21HM4NMC	15,000	1/4" H.P. to 3/8" NPT MALE	HM4	NMC	2"	3/4"
30-21HM4NMD	15,000	1/4" H.P. to 1/2" NPT MALE	HM4	NMD	2 1/8"	7/8"
10-21HM4NMF	10,000	1/4" H.P. to 3/4" NPT MALE	HM4	NMF	2 1/4"	1 1/8"
30-21HM6NMB	15,000	3/8" H.P. to 1/4" NPT MALE	HM6	NMB	2 1/8"	7/8"
30-21HM6NMC	15,000	3/8" H.P. to 3/8" NPT MALE	HM6	NMC	2 1/8"	7/8"
30-21HM9NMB	15,000	9/16" H.P. to 1/4" NPT MALE	HM9	NMB	2 3/8"	1 1/8"
30-21HM9NMC	15,000	9/16" H.P. to 3/8" NPT MALE	HM9	NMC	2 3/8"	1 1/8"
30-21HM9NMD	15,000	9/16" H.P. to 1/2" NPT MALE	HM9	NMD	2 1/2"	1 1/8"
10-21HM9NMF	10,000	9/16" H.P. to 3/4" NPT MALE	HM9	NMF	2 5/8"	1 1/8"
10-21HM9NMH	10,000	9/16" H.P. to 1" NPT MALE	HM9	NMH	2 3/4"	1 3/8"



## Male Pipe to Male Pipe

Catalog No.	Pressure Rating psi	Connections	A	B	Length	Hex Size
15-21NMBNMB	15,000	1/4" NPT MALE to 1/4" NPT MALE	NMB	NMB	1 7/8"	5/8"
15-21NMBNMC	15,000	1/4" NPT MALE to 3/8" NPT MALE	NMB	NMB	2"	3/4"
15-21NMCNMC	15,000	3/8" NPT MALE to 3/8" NPT MALE	NMC	NMC	2"	3/4"
15-21NMDNMD	15,000	1/2" NPT MALE to 1/2" NPT MALE	NMD	NMD	2 1/8"	1"





## High Pressure Equipment

### Male High Pressure to Male Medium Pressure



Catalog No.	Pressure Rating psi	Connections	A	B	Length	Hex Size
20-21HM4LM12	20,000	1/4" H.P. to 3/4" M.P.	HM4	LM12	2 5/8"	1 1/8"
20-21HM6LM12	20,000	3/8" H.P. to 3/4" M.P.	HM6	LM12	2 3/4"	1 1/8"
20-21HM9LM12	20,000	9/16" H.P. to 3/4" M.P.	HM9	LM12	3"	1 1/8"
20-21HM4LM16	20,000	1/4" H.P. to 1" M.P.	HM4	LM16	3 5/8"	1"
20-21HM6LM16	20,000	3/8" H.P. to 1" M.P.	HM6	LM16	4"	1"
20-21HM9LM16	20,000	9/16" H.P. to 1" M.P.	HM9	LM16	4"	1 1/8"

### Male High Pressure to Male High Pressure



Catalog No.	Pressure Rating psi	Connections	A	B	Length	Hex Size
60-21HM2HM2	60,000	1/8" H.P. to 1/8" H.P.	HM2	HM2	1 1/2"	1/2"
60-21HM2HM4	60,000	1/8" H.P. to 1/4" H.P.	HM2	HM4	1 5/8"	5/8"
60-21HM4HM4	60,000	1/4" H.P. to 1/4" H.P.	HM4	HM4	1 11/16"	5/8"
60-21HM4HM6	60,000	1/4" H.P. to 3/8" H.P.	HM4	HM6	2 1/16"	3/4"
60-21HM4HM9	60,000	1/4" H.P. to 9/16" H.P.	HM4	HM9	2 1/4"	1 1/8"
60-21HM6HM6	60,000	3/8" H.P. to 3/8" H.P.	HM6	HM6	2 1/4"	3/4"
60-21HM6HM9	60,000	3/8" H.P. to 9/16" H.P.	HM6	HM9	2 1/2"	1 1/8"
60-21HM9HM9	60,000	9/16" H.P. to 9/16" H.P.	HM9	HM9	2 5/8"	1 1/8"
30-21HM4HM16	30,000	1/4" H.P. to 1" M.P.	HM4	HM16	3 5/8"	1"
30-21HM6HM16	30,000	3/8" H.P. to 1" M.P.	HM6	HM16	4"	1"
30-21HM9HM16	30,000	9/16" H.P. to 1" M.P.	HM9	HM16	4"	1 1/8"



# NPT Fittings

## NPT Fittings

A complete line of couplings and adapters with NPT threaded connections are now available. These fittings feature 316 cold-worked stainless steel construction, with other materials available. HiP maintains an inventory of these fittings for quick ship requirements.

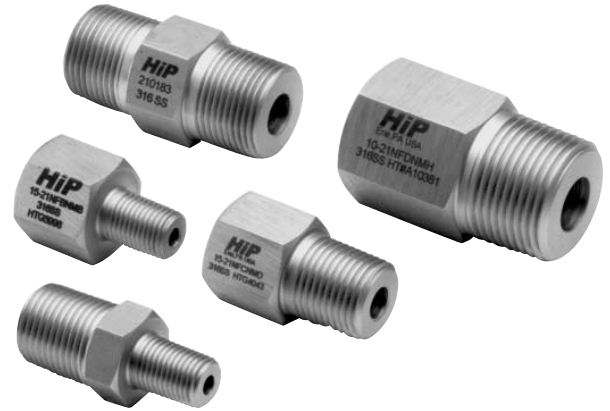

### NPT Straight Couplings

Catalog No.	Pressure Rating psi	Connections	A	B	Length	Hex Size
15-21NFA	15,000	1/8" FEMALE NPT x 1/8" FEMALE NPT	NFA	NFA	1 1/4"	3/4"
15-21NFB	15,000	1/4" FEMALE NPT x 1/4" FEMALE NPT	NFB	NFB	1 3/4"	1"
15-21NFC	15,000	3/8" FEMALE NPT x 3/8" FEMALE NPT	NFC	NFC	1 3/8"	1"
15-21NFD	15,000	1/2" FEMALE NPT x 1/2" FEMALE NPT	NFD	NFD	1 7/8"	1 3/8"
10-21NFF	10,000	3/4" FEMALE NPT x 3/4" FEMALE NPT	NFF	NFF	2 1/2"	1 3/8"
10-21NFH	10,000	1" FEMALE NPT x 1" FEMALE NPT	NFH	NFH	2 1/2"	1 3/4"

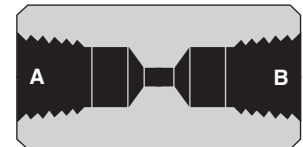

### NPT Reducer Couplings

Catalog No.	Pressure Rating psi	Connections	A	B	Length	Hex Size
15-21NFBNFC	15,000	1/4" FEMALE NPT x 3/8" FEMALE NPT	NFB	NFC	1 1/2"	1"
15-21NFBNFD	15,000	1/4" FEMALE NPT x 1/2" FEMALE NPT	NFB	NFD	2"	1 3/8"
15-21NFCNFD	15,000	3/8" FEMALE NPT x 1/2" FEMALE NPT	NFC	NFD	2"	1 3/8"

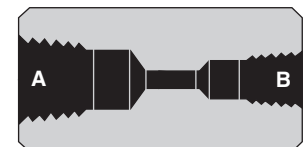

### Adapters: Male to Male NPT

Catalog No.	Pressure Rating psi	Connections	A	B	Length	Hex Size
15-21NMANMA	15,000	1/8" MALE NPT x 1/8" MALE NPT	NMA	NMA	1 3/4"	1/2"
15-21NMBNMB	15,000	1/4" MALE NPT x 1/4" MALE NPT	NMB	NMB	1 7/8"	5/8"
15-21NMCNMC	15,000	3/8" MALE NPT x 3/8" MALE NPT	NMC	NMC	2"	3/4"
15-21NMDNMD	15,000	1/2" MALE NPT x 1/2" MALE NPT	NMD	NMD	2 1/8"	1"
10-21NMFNMF	10,000	3/4" MALE NPT x 3/4" MALE NPT	NMF	NMF	2 3/8"	1 1/8"
10-21NMHNMH	10,000	1" MALE NPT x 1" MALE NPT	NMH	NMH	2 5/8"	1 3/8"
15-21NMBNMC	15,000	1/4" MALE NPT x 3/8" MALE NPT	NMB	NMC	2"	3/4"
15-21NMBNMD	15,000	1/4" MALE NPT x 1/2" MALE NPT	NMB	NMD	2"	7/8"
15-21NMCNMD	15,000	3/8" MALE NPT x 1/2" MALE NPT	NMC	NMD	2"	1"





## High Pressure Equipment

### Adapters: Female to Male NPT

Catalog No.	Pressure Rating psi	Connections	A	B	Length	Hex Size
15-21NFA <sup>N</sup> MA	15,000	1/8" FEMALE NPT x 1/8" MALE NPT	NFA	NMA	1 1/2"	3/4"
15-21NFA <sup>N</sup> MB	15,000	1/8" FEMALE NPT x 1/4" MALE NPT	NFA	NMB	1 3/4"	3/4"
15-21NFA <sup>N</sup> MC	15,000	1/8" FEMALE NPT x 3/8" MALE NPT	NFA	NMC	1 5/8"	3/4"
15-21NFA <sup>N</sup> MD	15,000	1/8" FEMALE NPT x 1/2" MALE NPT	NFA	NMD	1 3/4"	7/8"
15-21NFB <sup>N</sup> MA	15,000	1/8" FEMALE NPT x 1/8" MALE NPT	NFB	NMA	1 5/8"	3/4"
15-21NFB <sup>N</sup> MB	15,000	1/4" FEMALE NPT x 1/4" MALE NPT	NFB	NMB	1 5/8"	1"
15-21NFB <sup>N</sup> MC	15,000	1/4" FEMALE NPT x 3/8" MALE NPT	NFB	NMC	1 5/8"	1"
15-21NFB <sup>N</sup> MD	15,000	1/4" FEMALE NPT x 1/2" MALE NPT	NFB	NMD	1 3/4"	1"
15-21NFC <sup>N</sup> MB	15,000	3/8" FEMALE NPT x 1/4" MALE NPT	NFC	NMB	1 7/8"	1"
15-21NFC <sup>N</sup> MD	15,000	3/8" FEMALE NPT x 1/2" MALE NPT	NFC	NMD	1 3/4"	1"
15-21NFD <sup>N</sup> MA	15,000	1/2" FEMALE NPT x 1/8" MALE NPT	NFD	NMA	2"	1 3/8"
15-21NFD <sup>N</sup> MB	15,000	1/2" FEMALE NPT x 1/4" MALE NPT	NFD	NMB	2"	1 3/8"
15-21NFD <sup>N</sup> MC	15,000	1/2" FEMALE NPT x 3/8" MALE NPT	NFD	NMC	1 3/4"	1 3/8"
15-21NFD <sup>N</sup> MD	15,000	1/2" FEMALE NPT x 1/2" MALE NPT	NFD	NMD	2 1/4"	1 1/8"
10-21NFF <sup>N</sup> MD	10,000	3/4" FEMALE NPT x 1/2" MALE NPT	NFF	NMD	2 3/8"	1 3/8"
10-21NFF <sup>N</sup> MH	10,000	3/4" FEMALE NPT x 1" MALE NPT	NFF	NMH	2 3/8"	1 3/8"
10-21NFH <sup>N</sup> MD	10,000	1" FEMALE NPT x 1/2" MALE NPT	NFH	NMD	2 3/4"	1 7/8"
10-21NFH <sup>N</sup> MF	10,000	1" FEMALE NPT x 3/4" MALE NPT	NFH	NMF	2 3/4"	1 7/8"

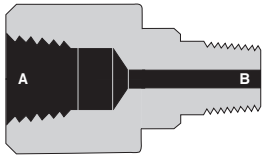

# Hose Fittings

## Hose Fittings

We now offer a line of hose adapters designed to easily and safely mate with standard type "M" fittings. Our new hose adapters are rated to the maximum working pressure of the hose or hose-end connection. Our hose fittings are constructed of 316 cold-worked stainless steel with other materials available. HiP maintains an inventory of these fittings for quick ship requirements.

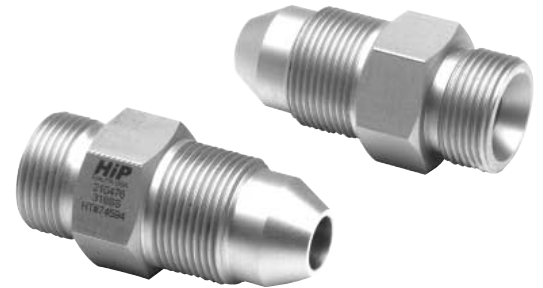

### High Pressure to Hose

Catalog No.	Pressure Rating psi	Connections	A	B	Length	Hex Size
40-21HM4HA9	40,000	1/4" H.P. x 9/16" HOSE	HM4	9/16"	1 3/4"	3/4"
30-21HM4HA12	30,000	1/4" H.P. x 3/4" HOSE	HM4	3/4"	1 7/8"	7/8"
26-21HM4HA16	26,000	1/4" H.P. x 1" HOSE	HM4	1"	2"	1 1/8"
40-21HM6HA9	40,000	3/8" H.P. x 9/16" HOSE	HM6	9/16"	2"	7/8"
30-21HM6HA12	30,000	3/8" H.P. x 3/4" HOSE	HM6	3/4"	2 1/8"	7/8"
26-21HM6HA16	26,000	3/8" H.P. x 1" HOSE	HM6	1"	2 1/4"	1 1/8"
40-21HM9HA9	40,000	9/16" H.P. x 9/16" HOSE	HM9	9/16"	2 1/4"	1 1/8"
30-21HM9HA12	30,000	9/16" H.P. x 3/4" HOSE	HM9	3/4"	2 3/8"	1 1/8"
26-21HM9HA16	26,000	9/16" H.P. x 1" HOSE	HM9	1"	2 3/8"	1 1/8"

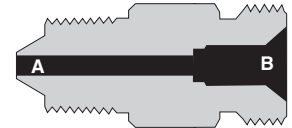

### Medium Pressure to Hose

Catalog No.	Pressure Rating psi	Connections	A	B	Length	Hex Size
20-21LM4HA9	20,000	1/4" M.P. x 9/16" HOSE	LM4	9/16"	1 7/8"	3/4"
20-21LM4HA12	20,000	1/4" M.P. x 3/4" HOSE	LM4	3/4"	2"	1"
20-21LM4HA16	20,000	1/4" M.P. x 1" HOSE	LM4	1"	2 1/8"	1 1/8"
20-21LM6HA9	20,000	3/8" M.P. x 9/16" HOSE	LM6	9/16"	1 7/8"	3/4"
20-21LM6HA12	20,000	3/8" M.P. x 3/4" HOSE	LM6	3/4"	2"	1"
20-21LM6HA16	20,000	3/8" M.P. x 1" HOSE	LM6	1"	2 1/8"	1 1/8"
20-21LM9HA9	20,000	9/16" M.P. x 9/16" HOSE	LM9	9/16"	2 1/8"	1"
20-21LM9HA12	20,000	9/16" M.P. x 3/4" HOSE	LM9	3/4"	2 1/4"	1"
20-21LM9HA16	20,000	9/16" M.P. x 1" HOSE	LM9	1"	2 1/4"	1 1/8"
20-21LM12HA9	20,000	3/4" M.P. x 9/16" HOSE	LM12	9/16"	2 1/4"	1 1/8"
20-21LM12HA12	20,000	3/4" M.P. x 3/4" HOSE	LM12	3/4"	2 3/8"	1 1/8"
20-21LM12HA16	20,000	3/4" M.P. x 1" HOSE	LM12	1"	2 3/8"	1 1/8"
20-21LM12HA21	20,000	3/4" M.P. x 1 5/16" HOSE	LM12	1 5/16"	2 3/4"	1 1/2"
20-21LM16HA9	20,000	1" M.P. x 9/16" HOSE	LM16	9/16"	3 5/8"	1 1/8"
20-21LM16HA12	20,000	1" M.P. x 3/4" HOSE	LM16	3/4"	3 3/4"	1 1/8"
20-21LM16HA16	20,000	1" M.P. x 1" HOSE	LM16	1"	3 3/4"	1 1/8"
20-21LM16HA21	20,000	1" M.P. x 1 5/16" HOSE	LM16	1 5/16"	4"	1 1/2"

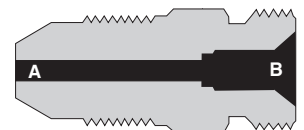



## High Pressure Equipment

### NPT to Hose

Catalog No.	Pressure Rating psi	Connections	A	B	Length	Hex Size
15-21NMBHA9	15,000	1/4" NPT MALE x 9/16" HOSE	NMB	9/16"	1 5/8"	5/8"
15-21NMBHA12	15,000	1/4" NPT MALE x 3/4" HOSE	NMB	3/4"	1 7/8"	7/8"
15-21NMBHA16	15,000	1/4" NPT MALE x 1" HOSE	NMB	1"	1 7/8"	1"
15-21NMCHA9	15,000	3/8" NPT MALE x 9/16" HOSE	NMC	9/16"	1 5/8"	3/4"
15-21NMCHA12	15,000	3/8" NPT MALE x 3/4" HOSE	NMC	3/4"	1 7/8"	7/8"
15-21NMCHA16	15,000	3/8" NPT MALE x 1" HOSE	NMC	1"	1 7/8"	1"
15-21NMDHA9	15,000	1/2" NPT MALE x 9/16" HOSE	NMD	9/16"	1 7/8"	7/8"
15-21NMDHA12	15,000	1/2" NPT MALE x 3/4" HOSE	NMD	3/4"	2"	7/8"
15-21NMDHA16	15,000	1/2" NPT MALE x 1" HOSE	NMD	1"	2"	1"
10-21NMFHA12	10,000	3/4" NPT MALE x 3/4" HOSE	NMF	3/4"	2"	1 1/8"
10-21NMFHA16	10,000	3/4" NPT MALE x 1" HOSE	NMF	1"	2"	1 1/8"
10-21NMHHA16	10,000	1" NPT MALE x 1" HOSE	NMH	1"	2 1/4"	1 3/8"



### Hose to Hose

Catalog No.	Pressure Rating psi	Connections	A	B	Length	Hex Size
26-21HA9HA9	26,000	9/16" HOSE x 9/16" HOSE	9/16"	9/16"	1 1/2"	3/4"
26-21HA9HA12	26,000	9/16" HOSE x 3/4" HOSE	9/16"	3/4"	1 5/8"	7/8"
26-21HA9HA16	26,000	9/16" HOSE x 1" HOSE	9/16"	1"	1 3/4"	1 1/8"
26-21HA12HA12	26,000	3/4" HOSE x 3/4" HOSE	3/4"	3/4"	1 3/4"	7/8"
26-21HA12HA16	26,000	3/4" HOSE x 1" HOSE	3/4"	1"	1 7/8"	1 1/8"
26-21HA16HA16	26,000	1" HOSE x 1" HOSE	1"	1"	1 7/8"	1 1/8"





## Straight Couplings Reducer Couplings

A complete range of couplings is offered for flexibility in going from tube to tube and from tube to pipe.

All standard coupling bodies are made from high tensile 316 stainless steel. Standard tubing glands and collars (sleeves) are provided with adapters unless otherwise specified.

### Taper Seal Straight Couplings

Catalog No.	Pressure Rating psi	Connections	A	B	Length	Hex Size
15-21AF1	15,000	1/16" O.D. TUBING	AF1	AF1	1"	3/8"
15-21AF2	15,000	1/8" O.D. TUBING	AF2	AF2	1 1/8"	3/4"
10-21AF4	10,000	1/4" O.D. TUBING	AF4	AF4	1 3/4"	1"
10-21AF6	10,000	3/8" O.D. TUBING	AF6	AF6	1 3/4"	1"

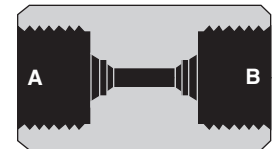

### Female Taper Seal to Female NPT

Catalog No.	Pressure Rating psi	Connections	A	B	Length	Hex Size
15-21AF1NFA	15,000	1/16" O.D. TUBE TO 1/8" NPT	AF1	NFA	1 1/8"	5/8"
15-21AF1NFB	15,000	1/16" O.D. TUBE TO 1/4" NPT	AF1	NFB	1 1/8"	3/4"
15-21AF1NFC	15,000	1/16" O.D. TUBE TO 3/8" NPT	AF1	NFC	1 3/8"	1"
15-21AF1NFD	15,000	1/16" O.D. TUBE TO 1/2" NPT	AF1	NFD	1 3/4"	1 1/8"
15-21AF2NFA	15,000	1/8" O.D. TUBE TO 1/8" NPT	AF2	NFA	1 1/4"	5/8"
15-21AF2NFB	15,000	1/8" O.D. TUBE TO 1/4" NPT	AF2	NFB	1 1/4"	3/4"
15-21AF2NFC	15,000	1/8" O.D. TUBE TO 3/8" NPT	AF2	NFC	1 1/2"	1"
15-21AF2NFD	15,000	1/8" O.D. TUBE TO 1/2" NPT	AF2	NFD	1 3/4"	1 1/8"
10-21AF4NFA	10,000	1/4" O.D. TUBE TO 1/8" NPT	AF4	NFA	1 5/8"	1"
10-21AF4NFB	10,000	1/4" O.D. TUBE TO 1/4" NPT	AF4	NFB	1 3/4"	1"
10-21AF4NFC	10,000	1/4" O.D. TUBE TO 3/8" NPT	AF4	NFC	1 7/8"	1"
10-21AF4NFD	10,000	1/4" O.D. TUBE TO 1/2" NPT	AF4	NFD	1 7/8"	1 1/8"
10-21AF4NFF	10,000	1/4" O.D. TUBE TO 3/4" NPT	AF4	NFF	2 3/8"	1 3/8"
10-21AF4NFH	10,000	1/4" O.D. TUBE TO 1" NPT	AF4	NFH	2 5/8"	1 7/8"
10-21AF6NFA	10,000	3/8" O.D. TUBE TO 1/8" NPT	AF6	NFA	1 5/8"	1"
10-21AF6NFB	10,000	3/8" O.D. TUBE TO 1/4" NPT	AF6	NFB	1 3/4"	1"
10-21AF6NFC	10,000	3/8" O.D. TUBE TO 3/8" NPT	AF6	NFC	1 7/8"	1"
10-21AF6NFD	10,000	3/8" O.D. TUBE TO 1/2" NPT	AF6	NFD	2 1/8"	1 1/8"
10-21AF6NFF	10,000	3/8" O.D. TUBE TO 3/4" NPT	AF6	NFF	2 3/8"	1 3/8"
10-21AF6NFH	10,000	3/8" O.D. TUBE TO 1" NPT	AF6	NFH	2 5/8"	1 7/8"

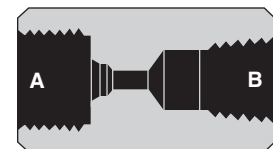





## High Pressure Equipment

### Female Taper Seal to Female High Pressure

Catalog No.	Pressure Rating psi	Connections	A	B	Length	Hex Size
15-21AF1HF2	15,000	1/16" O.D. TUBE TO 1/8" H.P.	AF1	HF2	1 1/8"	5/8"
15-21AF1HF4	15,000	1/16" O.D. TUBE TO 1/4" H.P.	AF1	HF4	1 1/4"	3/4"
15-21AF1HF6	15,000	1/16" O.D. TUBE TO 3/8" H.P.	AF1	HF6	1 3/8"	1"
15-21AF1HF9	15,000	1/16" O.D. TUBE TO 9/16" H.P.	AF1	HF9	2 3/8"	1 3/8"
15-21AF2HF2	15,000	1/8" O.D. TUBE TO 1/8" H.P.	AF2	HF2	1 1/8"	3/4"
15-21AF2HF4	15,000	1/8" O.D. TUBE TO 1/4" H.P.	AF2	HF4	1 1/4"	3/4"
15-21AF2HF6	15,000	1/8" O.D. TUBE TO 3/8" H.P.	AF2	HF6	1 7/8"	1"
15-21AF2HF9	15,000	1/8" O.D. TUBE TO 9/16" H.P.	AF2	HF9	2 3/8"	1 3/8"
10-21AF4HF2	10,000	1/4" O.D. TUBE TO 1/8" H.P.	AF4	HF2	1 3/8"	1"
10-21AF4HF4	10,000	1/4" O.D. TUBE TO 1/4" H.P.	AF4	HF4	1 1/2"	1"
10-21AF4HF6	10,000	1/4" O.D. TUBE TO 3/8" H.P.	AF4	HF6	1 7/8"	1"
10-21AF4HF9	10,000	1/4" O.D. TUBE TO 9/16" H.P.	AF4	HF9	2 3/8"	1 3/8"
10-21AF6HF2	10,000	1/4" O.D. TUBE TO 1/8" H.P.	AF6	HF2	1 1/2"	1"
10-21AF6HF4	10,000	3/8" O.D. TUBE TO 1/4" H.P.	AF6	HF4	1 3/4"	1"
10-21AF6HF6	10,000	3/8" O.D. TUBE TO 3/8" H.P.	AF6	HF6	1 7/8"	1"
10-21AF6HF9	10,000	3/8" O.D. TUBE TO 9/16" H.P.	AF6	HF9	2 3/8"	1 3/8"

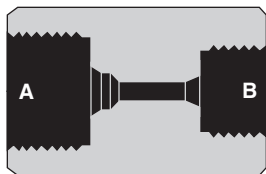

### Taper Seal Reducer Couplings

Catalog No.	Pressure Rating psi	Connections	A	B	Length	Hex Size
15-21AF1AF2	15,000	1/16" O.D. TO 1/8" O.D. TUBE	AF1	AF2	1 1/8"	5/8"
10-21AF1AF4	10,000	1/16" O.D. TO 1/4" O.D. TUBE	AF1	AF4	1 3/8"	1"
10-21AF1AF6	10,000	1/16" O.D. TO 3/8" O.D. TUBE	AF1	AF6	1 3/8"	1"
10-21AF2AF4	10,000	1/8" O.D. TO 1/4" O.D. TUBE	AF2	AF4	1 1/2"	1"
10-21AF2AF6	10,000	1/8" O.D. TO 3/8" O.D. TUBE	AF2	AF6	1 1/2"	1"
10-21AF4AF6	10,000	1/4" O.D. TO 3/8" O.D. TUBE	AF4	AF6	1 3/4"	1"



### Female Medium Pressure to Female Medium Pressure

Catalog No.	Pressure Rating psi	Connections	A	B	Length	Hex Size
20-21LF4LF6	20,000	1/4" M.P. to 3/8" M.P.	LF4	LF6	1 3/4"	3/4"
20-21LF4LF9	20,000	1/4" M.P. to 9/16" M.P.	LF4	LF9	2 1/8"	1"
20-21LF6LF9	20,000	3/8" M.P. to 9/16" M.P.	LF6	LF9	2 1/8"	1"
20-21LF4LF12	20,000	1/4" M.P. to 3/4" M.P.	LF4	LF12	2 1/2"	1 3/8"
20-21LF6LF12	20,000	3/8" M.P. to 3/4" M.P.	LF6	LF12	2 1/2"	1 3/8"
20-21LF9LF12	20,000	9/16" M.P. to 3/4" M.P.	LF9	LF12	2 1/2"	1 3/8"
20-21LF4LF16	20,000	1/4" M.P. to 1" M.P.	LF4	LF16	3 1/2"	1 3/4"
20-21LF6LF16	20,000	3/8" M.P. to 1" M.P.	LF6	LF16	3 1/2"	1 3/4"
20-21LF9LF16	20,000	9/16" M.P. to 1" M.P.	LF9	LF16	3 1/2"	1 3/4"
20-21LF12LF16	20,000	3/4" M.P. to 1" M.P.	LF12	LF16	3 1/2"	1 3/4"

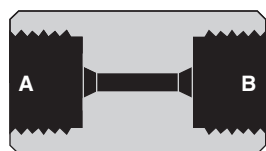

## Female Medium Pressure to Female Pipe

Catalog No.	Pressure Rating psi	Connections	A	B	Length	Hex Size
20-21LF4NFA	15,000	1/4" M.P. to 1/8" NPT FEMALE	LF4	NFA	1 5/8"	3/4"
20-21LF4NFB	15,000	1/4" M.P. to 1/4" NPT FEMALE	LF4	NFB	1 5/8"	3/4"
20-21LF4NFC	15,000	1/4" M.P. to 3/8" NPT FEMALE	LF4	NFC	2"	1"
20-21LF4NFD	15,000	1/4" M.P. to 1/2" NPT FEMALE	LF4	NFD	2"	1 1/8"
10-21LF4NFF	10,000	1/4" M.P. to 3/4" NPT FEMALE	LF4	NFF	2 3/8"	1 3/8"
10-21LF4NFH	10,000	1/4" M.P. to 1" NPT FEMALE	LF4	NFH	2 5/8"	1 7/8"
20-21LF6NFA	15,000	3/8" M.P. to 1/8" NPT FEMALE	LF6	NFA	1 3/4"	3/4"
20-21LF6NFB	15,000	3/8" M.P. to 1/4" NPT FEMALE	LF6	NFB	1 3/4"	3/4"
20-21LF6NFC	15,000	3/8" M.P. to 3/8" NPT FEMALE	LF6	NFC	2 1/8"	1"
20-21LF6NFD	15,000	3/8" M.P. to 1/2" NPT FEMALE	LF6	NFD	2 1/8"	1 1/8"
10-21LF6NFF	10,000	3/8" M.P. to 3/4" NPT FEMALE	LF6	NFIF	2 3/8"	1 3/8"
10-21LF6NFH	10,000	3/8" M.P. to 1" NPT FEMALE	LF6	NFH	2 3/4"	1 7/8"
20-21LF9NFA	15,000	9/16" M.P. to 1/8" NPT FEMALE	LF9	NFA	2 1/8"	1"
20-21LF9NFB	15,000	9/16" M.P. to 1/4" NPT FEMALE	LF9	NFB	2 1/8"	1"
20-21LF9NFC	15,000	9/16" M.P. to 3/8" NPT FEMALE	LF9	NFC	2 1/8"	1"
20-21LF9NFD	15,000	9/16" M.P. to 1/2" NPT FEMALE	LF9	NFD	2 1/4"	1 1/8"
10-21LF9NFF	10,000	9/16" M.P. to 3/4" NPT FEMALE	LF9	NFF	2 1/2"	1 3/8"
10-21LF9NFH	10,000	9/16" M.P. to 1" NPT FEMALE	LF9	NFH	2 7/8"	1 7/8"
20-21LF12NFA	15,000	3/4" M.P. to 1/8" NPT FEMALE	LF12	NFA	2 1/2"	1 3/8"
20-21LF12NFB	15,000	3/4" M.P. to 1/4" NPT FEMALE	LF12	NFB	2 1/2"	1 3/8"
20-21LF12NFC	15,000	3/4" M.P. to 3/8" NPT FEMALE	LF12	NFC	2 1/2"	1 3/8"
20-21LF12NFD	15,000	3/4" M.P. to 1/2" NPT FEMALE	LF12	NFD	2 1/2"	1 3/8"
10-21LF12NFF	10,000	3/4" M.P. to 3/4" NPT FEMALE	LF12	NFF	2 3/4"	1 1/2"
10-21LF12NFH	10,000	3/4" M.P. to 1" NPT FEMALE	LF12	NFH	3"	1 7/8"
20-21LF16NFA	15,000	1" M.P. to 1/8" NPT FEMALE	LF16	NFA	3"	1 3/4"
20-21LF16NFB	15,000	1" M.P. to 1/4" NPT FEMALE	LF16	NFB	3"	1 3/4"
20-21LF16NFC	15,000	1" M.P. to 3/8" NPT FEMALE	LF16	NFC	3"	1 3/4"
20-21LF16NFD	15,000	1" M.P. to 1/2" NPT FEMALE	LF16	NFD	3"	1 3/4"
10-21LF16NFF	10,000	1" M.P. to 3/4" NPT FEMALE	LF16	NFF	3 1/4"	1 3/4"
10-21LF16NFH	10,000	1" M.P. to 1" NPT FEMALE	LF16	NFH	3 1/4"	1 3/4"

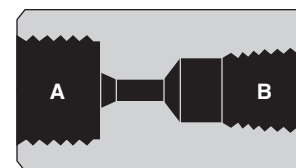

## Medium Pressure Straight Couplings

Catalog No.	Pressure Rating psi	Connections	A	B	Length	Hex Size
20-21LF4	20,000	1/4" O.D. TUBING	LF4	LF4	1 9/16"	5/8"
20-21LF6	20,000	3/8" O.D. TUBING	LF6	LF6	1 3/4"	3/4"
20-21LF9	20,000	9/16" O.D. TUBING	LF9	LF9	2 1/8"	1
20-21LF12	20,000	3/4" O.D. TUBING	LF12	LF12	2 1/2"	1 3/8"
20-21LF16	20,000	1" O.D. TUBING	LF16	LF16	3 1/2"	1 3/4"

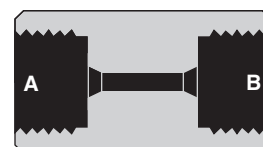



## High Pressure Equipment

### Female Medium Pressure to Female High Pressure

Catalog No.	Pressure Rating psi	Connections	A	B	Length	Hex Size
20-21LF4HF4	20,000	1/4" M.P. to 1/4" H.P.	LF4	HF4	1 5/8"	3/4"
20-21LF4HF6	20,000	1/4" M.P. to 3/8" H.P.	LF4	HF6	1 7/8"	1"
20-21LF4HF9	20,000	1/4" M.P. to 9/16" H.P.	LF4	HF9	2 3/8"	1 3/8"
20-21LF6HF4	20,000	3/8" M.P. to 1/4" H.P.	LF6	HF4	1 3/4"	3/4"
20-21LF6HF6	20,000	3/8" M.P. to 3/8" H.P.	LF6	HF6	1 7/8"	1"
20-21LF6HF9	20,000	3/8" M.P. to 9/16" H.P.	LF6	HF9	2 3/8"	1 3/8"
20-21LF9HF4	20,000	9/16" M.P. to 1/4" H.P.	LF9	HF4	2 1/8"	1"
20-21LF9HF6	20,000	9/16" M.P. to 3/8" H.P.	LF9	HF6	2 1/8"	1"
20-21LF9HF9	20,000	9/16" M.P. to 9/16" H.P.	LF9	HF9	2 3/8"	1 3/8"
20-21LF12HF4	20,000	3/4" M.P. to 1/4" H.P.	LF12	HF4	2 1/2"	1 3/8"
20-21LF12HF6	20,000	3/4" M.P. to 3/8" H.P.	LF12	HF6	2 1/2"	1 3/8"
20-21LF12HF9	20,000	3/4" M.P. to 9/16" H.P.	LF12	HF9	2 1/2"	1 3/8"
* 20-21HF16HF4	20,000	1" M.P. to 1/4" H.P.	HF16	HF4	3 1/2"	1 3/8"
* 20-21HF16HF6	20,000	1" M.P. to 3/8" H.P.	HF16	HF6	3 1/2"	1 3/8"
* 20-21HF16HF9	20,000	1" M.P. to 9/16" H.P.	HF16	HF9	3 1/2"	1 3/8"

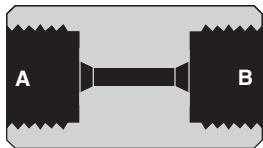

\* Can be rated to 30,000 psi if used with 1" O.D. x 7/16" I.D. tubing.

### High Pressure Straight Couplings

Catalog No.	Pressure Rating psi	Connections	A	B	Length	Hex Size
60-21HF2	60,000	1/8" O.D. TUBING	HF2	HF2	1 1/8"	3/4"
60-21HF4	60,000	1/4" O.D. TUBING	HF4	HF4	1 3/4"	1"
60-21HF6	60,000	3/8" O.D. TUBING	HF6	HF6	2"	1"
60-21HF9	60,000	9/16" O.D. TUBING	HF9	HF9	2 3/8"	1 3/8"
30-21HF16	30,000	1" O.D. TUBING	HF16	HF16	3 1/2"	1 3/4"

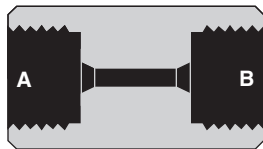

### High Pressure Reducer Couplings

Catalog No.	Pressure Rating psi	Connections	A	B	Length	Hex Size
60-21HF2HF4	60,000	1/8" O.D. TO 1/4" O.D. TUBE	HF2	HF4	1 1/4"	3/4"
60-21HF2HF6	60,000	1/8" O.D. TO 3/8" O.D. TUBE	HF2	HF6	1 5/8"	1"
60-21HF2HF9	60,000	1/16" O.D. TO 9/16" O.D. TUBE	HF2	HF9	1 3/4"	1 3/8"
60-21HF4HF6	60,000	1/4" O.D. TO 3/8" O.D. TUBE	HF4	HF6	1 5/8"	1"
60-21HF4HF9	60,000	1/4" O.D. TO 9/16" O.D. TUBE	HF4	HF9	1 3/4"	1 3/8"
60-21HF6HF9	60,000	3/8" O.D. TO 9/16" O.D. TUBE	HF6	HF9	2"	1 3/8"

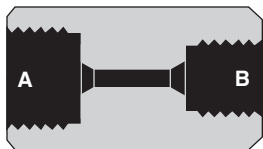

## Female High Pressure to Female NPT Pipe

Catalog No.	Pressure Rating psi	Connections	A	B	Length	Hex Size
30-21HF2NFA	15,000	1/8" O.D. TUBE TO 1/8" NPT	HF2	NFA	1 1/2"	3/4"
30-21HF2NFB	15,000	1/8" O.D. TUBE TO 1/4" NPT	HF2	NFB	1 1/2"	3/4"
30-21HF2NFC	15,000	1/8" O.D. TUBE TO 3/8" NPT	HF2	NFC	1 1/2"	1"
30-21HF2NFD	15,000	1/8" O.D. TUBE TO 1/2" NPT	HF2	NFD	1 3/4"	1 1/8"
10-21HF2NFF	10,000	1/8" O.D. TUBE TO 3/4" NPT	HF2	NFF	2"	1 3/8"
10-21HF2NFH	10,000	1/8" O.D. TUBE TO 1" NPT	HF2	NFH	2 1/2"	1 3/4"
30-21HF4NFA	15,000	1/4" O.D. TUBE TO 1/8" NPT	HF4	NFA	1 1/2"	1"
30-21HF4NFB	15,000	1/4" O.D. TUBE TO 1/4" NPT	HF4	NFB	1 1/2"	1"
30-21HF4NFC	15,000	1/4" O.D. TUBE TO 3/8" NPT	HF4	NFC	1 7/8"	1"
30-21HF4NFD	15,000	1/4" O.D. TUBE TO 1/2" NPT	HF4	NFD	1 7/8"	1 1/8"
10-21HF4NFF	10,000	1/4" O.D. TUBE TO 3/4" NPT	HF4	NFF	2"	1 3/8"
10-21HF4NFH	10,000	1/4" O.D. TUBE TO 1" NPT	HF4	NFH	2 1/2"	1 3/4"
30-21HF6NFA	15,000	3/8" O.D. TUBE TO 1/8" NPT	HF6	NFA	1 7/8"	1"
30-21HF6NFB	15,000	3/8" O.D. TUBE TO 1/4" NPT	HF6	NFB	1 7/8"	1"
30-21HF6NFC	15,000	3/8" O.D. TUBE TO 3/8" NPT	HF6	NFC	1 7/8"	1"
30-21HF6NFD	15,000	3/8" O.D. TUBE TO 1/2" NPT	HF6	NFD	1 7/8"	1 1/8"
10-21HF6NFF	10,000	3/8" O.D. TUBE TO 3/4" NPT	HF6	NFF	2 1/8"	1 3/8"
10-21HF6NFH	10,000	3/8" O.D. TUBE TO 1" NPT	HF6	NFH	2 5/8"	1 7/8"
30-21HF9NFA	15,000	9/16" O.D. TUBE TO 1/8" NPT	HF9	NFA	2 3/8"	1 3/8"
30-21HF9NFB	15,000	9/16" O.D. TUBE TO 1/4" NPT	HF9	NFB	2 3/8"	1 3/8"
30-21HF9NFC	15,000	9/16" O.D. TUBE TO 3/8" NPT	HF9	NFC	2 3/8"	1 3/8"
30-21HF9NFD	15,000	9/16" O.D. TUBE TO 1/2" NPT	HF9	NFD	2 3/8"	1 3/8"
10-21HF9NFF	10,000	9/16" O.D. TUBE TO 3/4" NPT	HF9	NFF	2 3/8"	1 3/8"
10-21HF9NFH	10,000	9/16" O.D. TUBE TO 1" NPT	HF9	NFH	2 5/8"	2"

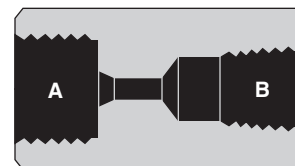

High Pressure Equipment offers an extensive selection of couplings and adapters to meet virtually every requirement.



## High Pressure Equipment

### Thermocouple Adapters

The  $\frac{1}{16}$ " O.D. and  $\frac{1}{8}$ " O.D. tubing sizes of the Taper Seal connections are ideally suited for use with thermocouples for pressures up to 15,000 psi.

These connectors do not bite into the outer wall of the thermocouple, but rather clamp onto the tubing (or thermocouple) similar to a machine collet. A thread lubricant is recommended on the gland nut when initially making up the connection, but such lubrication can later be removed if desired. Material is high tensile 316 stainless steel. Standard glands and sleeves are provided unless otherwise specified.

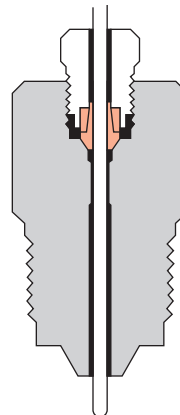

#### Adapters for $\frac{1}{16}$ " TC's

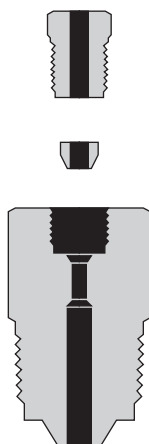

Catalog No.	Pressure Rating psi	Male End of Adapter	Length	Hex Size
15-21AF1AM2-T	15,000	$\frac{1}{8}$ " TAPER SEAL	$\frac{7}{8}$ "	$\frac{1}{2}$ "
10-21AF1AM4-T	10,000	$\frac{1}{4}$ " TAPER SEAL	$1\frac{1}{4}$ "	$\frac{3}{4}$ "
10-21AF1AM6-T	10,000	$\frac{3}{8}$ " TAPER SEAL	$1\frac{1}{4}$ "	$\frac{3}{4}$ "
15-21AF1HM2-T	15,000	$\frac{1}{8}$ " HIGH PRESSURE	$\frac{7}{8}$ "	$\frac{1}{2}$ "
15-21AF1HM4-T	15,000	$\frac{1}{4}$ " HIGH PRESSURE	$1\frac{1}{4}$ "	$\frac{5}{8}$ "
15-21AF1HM6-T	15,000	$\frac{3}{8}$ " HIGH PRESSURE	$1\frac{3}{4}$ "	$\frac{3}{4}$ "
15-21AF1HM9-T	15,000	$\frac{9}{16}$ " HIGH PRESSURE	$2\frac{1}{8}$ "	$1\frac{1}{8}$ "
15-21AF1NMA-T	15,000	$\frac{1}{8}$ " NPT	1"	$\frac{1}{2}$ "
15-21AF1NMB-T	15,000	$\frac{1}{4}$ " NPT	$1\frac{1}{4}$ "	$\frac{5}{8}$ "
15-21AF1NMC-T	15,000	$\frac{3}{8}$ " NPT	$1\frac{3}{8}$ "	$\frac{3}{4}$ "
15-21AF1NMD-T	15,000	$\frac{1}{2}$ " NPT	$1\frac{3}{4}$ "	1"
10-21AF1NMF-T	10,000	$\frac{3}{4}$ " NPT	$1\frac{7}{8}$ "	$1\frac{3}{8}$ "
10-21AF1NMH-T	10,000	1" NPT	$1\frac{5}{8}$ "	$1\frac{3}{8}$ "

#### Adapters for $\frac{1}{8}$ " TC's

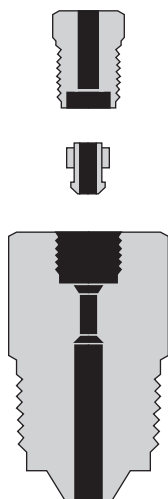

Catalog No.	Pressure Rating psi	Male End of Adapter	Length	Hex Size
10-21AF2AM4-T	10,000	$\frac{1}{4}$ " TAPER SEAL	$1\frac{1}{4}$ "	$\frac{3}{4}$ "
10-21AF2AM6-T	10,000	$\frac{3}{8}$ " TAPER SEAL	$1\frac{1}{4}$ "	$\frac{3}{4}$ "
15-21AF2HM4-T	15,000	$\frac{1}{4}$ " HIGH PRESSURE	$1\frac{1}{4}$ "	$\frac{5}{8}$ "
15-21AF2HM6-T	15,000	$\frac{3}{8}$ " HIGH PRESSURE	$1\frac{3}{4}$ "	$\frac{3}{4}$ "
15-21AF2HM9-T	15,000	$\frac{9}{16}$ " HIGH PRESSURE	$2\frac{1}{8}$ "	$1\frac{1}{8}$ "
15-21AF2NMA-T	15,000	$\frac{1}{8}$ " NPT	$1\frac{1}{4}$ "	$\frac{3}{4}$ "
15-21AF2NMB-T	15,000	$\frac{1}{4}$ " NPT	$1\frac{1}{4}$ "	$\frac{5}{8}$ "
15-21AF2NMC-T	15,000	$\frac{3}{8}$ " NPT	$1\frac{3}{8}$ "	$\frac{3}{4}$ "
15-21AF2NMD-T	15,000	$\frac{1}{2}$ " NPT	$1\frac{3}{4}$ "	1"
10-21AF2NMF-T	10,000	$\frac{3}{4}$ " NPT	$1\frac{7}{8}$ "	$1\frac{3}{8}$ "
10-21AF3NMH-T	10,000	1" NPT	$1\frac{5}{8}$ "	$1\frac{3}{8}$ "



## Pressure Gauges



Standard pressure gauges as shown are available from stock for immediate delivery. Gauge models 4PG5 through 6PG50 are standard with a High Pressure  $\frac{1}{4}$ " O.D. tubing connection (HF4), while models 6PG75, 6PG100 and 6PG150 have a Ultra High Pressure  $\frac{3}{8}$ " O.D. tubing connection (XF6). These coned and threaded connections are machined directly into the bottom inlet of the gauges. Adapters for other size connections are available from stock.

These gauges have a solid front separating the dial face from the pressure tube in order to provide maximum safety. Bourdon tube and socket are 316 S.S. on all gauges. Both styles include a safety blowout back. 5,000 psi to 30,000 psi gauges have laminated safety glass, while the 50,000 psi to 150,000 psi style have a removable polycarbonate plastic front window.

Gauges may be used intermittently to 100 percent of dial reading. Accuracy on 5,000 psi and 10,000 psi models is  $\frac{1}{2}\%$  of full scale reading. Accuracy on 20,000 psi through 30,000 psi models is 1% of full scale reading. Accuracy on 50,000 psi through 150,000 psi models is  $\frac{1}{2}\%$  of full scale reading.

PANEL MOUNTING: 4PG5, 4PG10, 6PG20, 6PG30

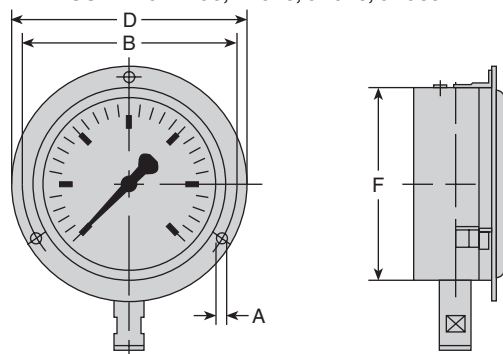

SURFACE MOUNTING: 6PG50, 6PG75, 6PG100

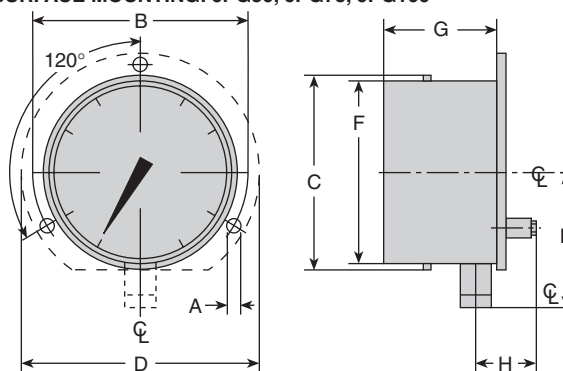

### Standard Gauges In Stock

Gauge Size			Materials				
Catalog No.	Range psi	Dial Size	Graduations			Mounting	Case
4PG5	0-5,000	4"	500	100	50	Panel	316 S.S.
4PG10	0-10,000	4"	1,000	500	100		
6PG20	0-20,000	6"	2,000	1,000	200		
6PG30	0-30,000	6"	3,000	1,000	200		
6PG50	0-50,000	6"	5,000	2,500	500	*Surface	Heavy Duty Alum.
6PG75	0-75,000	6"	10,000	2,500	500		
6PG100	0-100,000	6"	10,000	5,000	1,000		
6PG150	0-150,000	6"	20,000	10,000	1,000		

\* Panel mount kit available. Contact factory.

### Dimensions

Dial Size	A	B	C	D	E	F	G	H
4" 4PG5, 4PG10	$\frac{3}{16}$ "	$4\frac{35}{64}$ "	—	$5\frac{5}{16}$ "	—	$3\frac{7}{8}$ "	—	—
6" 6PG20, 6PG30	$\frac{7}{32}$ "	7"	—	$7\frac{11}{16}$ "	—	$6\frac{1}{4}$ " - $6\frac{5}{16}$ "	—	—
6" 6PG50, 6PG75, 6PG100, 6PG150	$\frac{9}{32}$ "	7"	$6\frac{5}{8}$ "	$7\frac{5}{8}$ "	$4\frac{3}{8}$ "	$6\frac{3}{8}$ "	$3\frac{5}{8}$ "	$1\frac{3}{4}$ "